

Timken Bearing Damage Analysis with Lubrication Reference Guide



TIMKEN

⚠ WARNING

Failure to observe the following warnings could create a risk of death or serious injury.

Proper maintenance and handling procedures are critical. Always follow installation instructions and maintain proper lubrication.

Never spin a bearing with compressed air. The rollers may be forcefully expelled.

Overheated bearings can ignite explosive atmospheres. Special care must be taken to properly select, install, maintain, and lubricate bearings that are used in or near atmospheres that may contain explosive levels of combustible gases or accumulations of dust such as from grain, coal, or other combustible materials. Consult your equipment designer or supplier for installation and maintenance instructions.

If hammer and bar are used for installation or removal of a part, use a mild steel bar (e.g., 1010 or 1020 grade). Mild steel bars are less likely to cause release of high-speed fragments from the hammer, bar or the part being removed.

⚠ WARNING

Failure to observe the following warnings could create a risk of serious injury.

Tensile stresses can be very high in tightly fitted bearing components. Attempting to remove such components by cutting the cone (inner race) may result in a sudden shattering of the component causing fragments of metal to be forcefully expelled. Always use properly guarded presses of bearing pullers to remove bearings from shafts, and always use suitable personal protective equipment, including safety glasses.

CAUTION

Failure to follow these cautions may result in property damage.

Do not use damaged bearings.

Do not use damaged housed units.

NOTE

Do not use excessive force when mounting or dismounting the unit.

Follow all tolerance, fit, and torque recommendations.

Always follow the Original Equipment Manufacturer's installation and maintenance guidelines.

Ensure proper alignment.

Never weld housed units.

Do not heat components with an open flame.

Do not operate at bearing temperatures above 121° C (250° F).

DISCLAIMER

This catalog is provided solely to give you analysis tools and data to assist you in your product selection. Product performance is affected by many factors beyond the control of Timken. Therefore, you must validate the suitability and feasibility of all product selections for your applications.

Timken products are sold subject to Timken terms and conditions of sale, which include our limited warranty and remedy. You can find these at www.timken.com/termsandconditionsofsale.

Please consult with your Timken engineer for more information and assistance.

Every reasonable effort has been made to ensure the accuracy of the information in this writing, but no liability is accepted for errors, omissions or for any other reason.

Warnings for this product line are in this catalog and posted on www.timken.com/warnings.



Let's face it – bearings work in a tough world.

Excessive contamination. Poor lubrication. High heats. Heavy vibrations. These merely scratch the surface of all the wear and tear your bearings go through on a given day.

That's where the knowledge and precision of Timken come into play.

Our sales and service engineering teams solve problems and offer solutions for customers in virtually every industry. Couple this experience with a long-standing history in material science and tribology, and you gain a team of experts uniquely qualified to help you analyze bearing damage.

And we want to share this knowledge with you. We developed this reference guide to help you identify some of the most common types of bearing damage, explaining the possible causes and discussing the necessary actions needed to avoid them. We also include useful bearing references and lubrication guidelines you can follow.

If your bearing damage goes beyond what we cover, or if you just need help getting started, call us. Our service engineers can work with you – often on-site – to get to the root cause of your problems. We even offer in-depth training that's customized to your specific industry or application.

It's a tough world out there. Let us help you make your business roll forward more smoothly.



Reference the *Timken Industrial Bearing Maintenance Manual* (Order No. 10213) for additional information.

Table of Contents

Preparation and Approach to Bearing Damage Analysis	6
Types of Bearing Damage	
Wear – Abrasive Contamination	7
Wear – Pitting and Bruising	8
Wear – Grooving	8
Etching – Corrosion	9
Inadequate Lubrication	10
Fatigue Spalling	12
Excessive Preload or Overload	13
Excessive Endplay	14
Misalignment and Inaccurate Seat and Shoulder Machining	14
Handling and Installation Damage	15
Damaged Bearing Cages or Retainers	16
High Spots and Fitting Practices	17
Improper Fit in Housings or Shafts	18
Brinell and Impact Damage	19
False Brinelling	20
Burns from Electric Current	21
Cam Fracture	21
Understanding Bearing Life	
Bearing Service Life	22
Lubrication Reference Guide	
Factors that Impact Lubrication Performance	23
Lubrication Guidelines – Required Grease Quantity	26
Glossary	27
Types of Bearings and Nomenclature	29
Tapered Roller Bearing Speed Capability Guidelines	30
Temperature Guidelines for Roller Bearing Installation	31
Cone Bore Growth Expansion Rates	32
Conversion Equivalents for U.S. and Metric Measurements	33
Conversion Chart Showing Millimeter, Fractional and Decimal Inch Sizes	34
Temperature Conversion Table	35
Timken Bearing Solutions	36
Timken Product and Service Solutions	38

Preparation and Approach to Bearing Damage Analysis

Bearing Damage: Overview of the Facts

Timken analyzes bearings from operations across the world. Our bearing service and repair specialists find that fully 50 percent of the bearings submitted to us haven't reached their calculated lives.

In some cases, the cause is contact fatigue (inclusion origin, point surface origin, geometric stress concentration and micro-spalling). In 90 percent of the cases, though, the cause is non-fatigue factors, including:

- Foreign materials.
- Corrosion.
- Inadequate lubrication.
- Improper handling.
- Bad running conditions.

If you're concerned that your bearing is deteriorating, look for the following signs:

- Vibrations – whether felt by hand or measured with a frequency analyzer.
- Abnormal noises.
- Displacement of rotational centerline.
- Running temperature increase.
- Odd smells.
- Lubricant deterioration.
- Lubricant leakage.
- Visual discovery during routine maintenance check.

Suggested Procedure for Bearing Analysis

Follow the steps below for an accurate and complete analysis when investigating any bearing damage or system breakdowns. If you need help, contact one of our sales or service engineers.

1. Gather operating data from bearing monitoring devices; analyze service and maintenance records and charts; and secure application diagrams, graphics or engineering drawings.
2. Prepare an inspection sheet to capture all your observations. Take photographs throughout the procedure to help document or describe the damaged components.
3. Extract any used lubricant samples from bearings, housing and seal areas to determine lubricant conditions. Package it separately and label it properly.
4. Secure a sample of new, unused lubricant. Record any specification or batch information from the container. Obtain the technical specifications and any related material safety data (handling, disposal, toxicological) documentation to accompany lubricant shipments.
5. Check the bearing environment for external influences, like other equipment problems, that preceded or occurred at the same time bearing damage was reported.
6. Disassemble the equipment (either partially or completely). Record an assessment of the mounted bearing condition.
7. Inspect other machine elements, especially the position and condition of components adjacent to the bearing, including locknuts, adapters, seals and seal wear rings.
8. Mark and record the mounted position of the bearings and components prior to removal.
9. Measure and verify shaft and housing size, roundness and taper using certified gauges.
10. Following removal, but before cleaning, record observations of lubricant distribution and condition.
11. Clean parts and record the manufacturers' information from markings on the bearing rings (part number, serial number, date code).
12. Analyze the condition of the internal rolling contact surfaces, load zones and the corresponding external surfaces.
13. Apply preservative oil and repackage the bearings to avoid corrosion.
14. Compile a summary report of all data for discussion with Timken sales or service engineers.

Types of Bearing Damage

Many different operating conditions can cause bearing damage. Those listed in this section make up the most commonly identified causes of damage for anti-friction bearings, including cylindrical, spherical, tapered and ball designs. Remember that you must follow proper bearing maintenance and handling practices to ensure your bearings achieve optimal performance levels.

Wear – Abrasive Contamination

Foreign particles cause wear and damage. Foreign particle contamination can cause abrasive wear, bruising or circumferential lining (grooving).

Abrasive Wear

Fine foreign material in the bearing can cause excessive abrasive wear. Sand, fine metal from grinding or machining, and fine metal or carbides from gears wear or lap the rolling elements and races. In tapered bearings, the roller ends and cone rib wear to a greater degree than the races. This wear causes increased endplay or internal clearance, which can reduce fatigue life and create misalignment in the bearing. Abrasive wear also can affect other parts of the machine in which the bearings are used. The foreign particles may get in through badly worn or defective seals. Improper initial cleaning of housings and parts, ineffective filtration or improper filter maintenance can allow abrasive particles to accumulate.

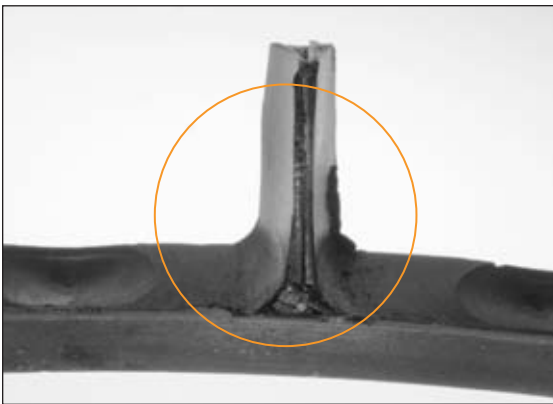

Fig. 1. Fine particle contamination entered this spherical roller bearing and generated wear between the cage surfaces, rollers and races.

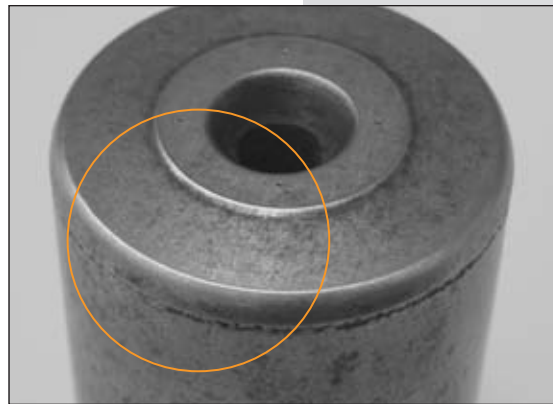

Fig. 2. The roller end wear on this spherical bearing also was caused by fine particle contamination.



Fig. 3. Fine particle contamination caused abrasive wear on this tapered roller bearing.

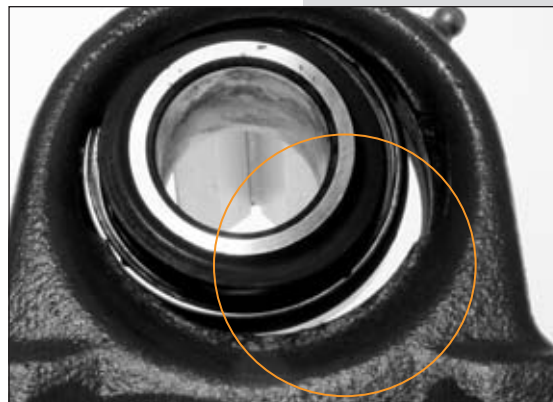

Fig. 4. Exposure to abrasives and water in a severe environment caused extreme wear on this pillow block bearing.

Wear – Pitting and Bruising

Hard particles rolling through the bearing may cause pitting and bruising of the rolling elements and races. Metal chips or large particles of dirt remaining in improperly cleaned housings can initiate early fatigue damage.

Common external debris contaminants include dirt, sand and environmental particles. Typical causes of internal debris contamination include wear from gears, splines, seals, clutches, brakes, joints, improperly cleaned housings, and damaged or spalled components. These hard particles travel within the lubrication, through the bearing and eventually bruise (dent) the surfaces. Raised metal around the dents acts as surface-stress risers to cause premature spalling and reduce bearing life.

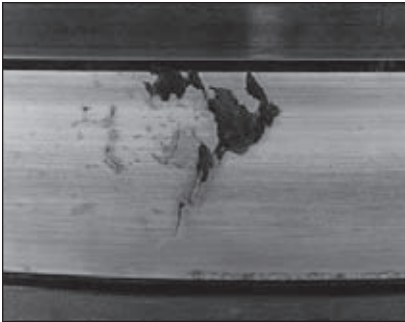

Fig. 5. A tapered roller bearing inner race (cone) with spalling from debris contamination bruises.

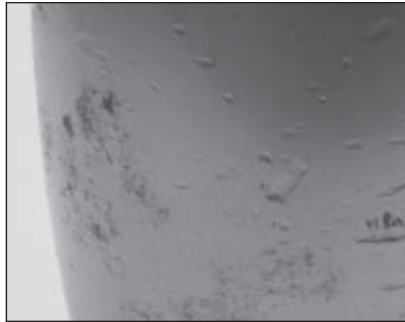

Fig. 6. Hard particles caused contamination bruising on this spherical roller bearing.



Fig. 7. Debris from other fatigued parts, inadequate sealing or poor maintenance caused bruising on this tapered roller bearing race.

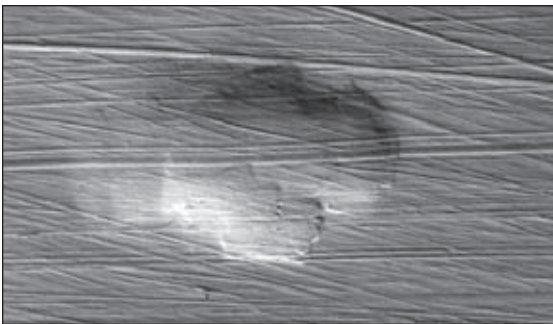

Fig. 8. This photo, taken with a microscope, shows a debris contamination bruise on a bearing race. A corresponding surface map of the dent is shown in Fig. 9.

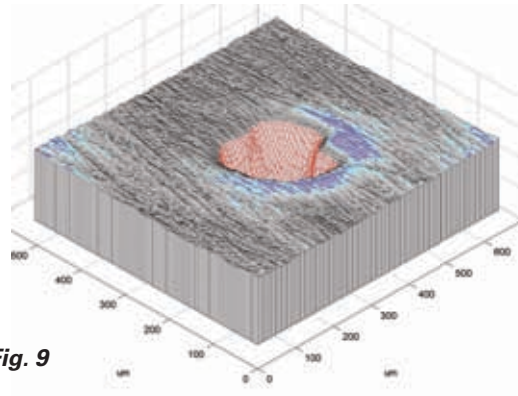

Fig. 9

Wear – Grooving

Extremely heavy wear from chips or metal particles can cause grooving. These contaminants become wedged in the soft cage material and cut grooves in the rolling elements. This condition generates improper rolling contact geometry and can reduce service life.

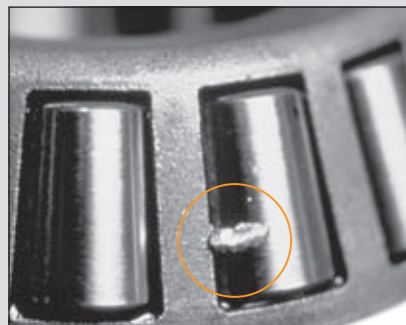

Fig. 10. Large particle contamination imbedded into the soft cage material can result in grooving and circumferential lining of the rollers and raceways.

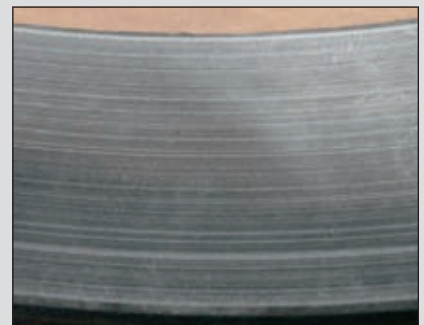

Fig. 11. Horizontal grooves cause improper rolling contact, reducing bearing life.

Etching – Corrosion

Etching (or corrosion) remains one of the most serious problems anti-friction bearings encounter. Without adequate protection, the high degree of surface finish on races and rolling elements makes them susceptible to corrosion damage from moisture and water.

Etching is most often caused by condensate collecting in the bearing housing from temperature changes. Moisture or water can get in through damaged, worn or inadequate seals. Improperly washing and drying bearings when you remove them for inspection also can cause considerable damage. After cleaning and drying or preparing bearings for storage, you should coat them with oil or another preservative and wrap them in protective paper. You should always store bearings, new or used, in a dry area and keep them in original packaging to reduce the risk of static corrosion appearing before mounting.

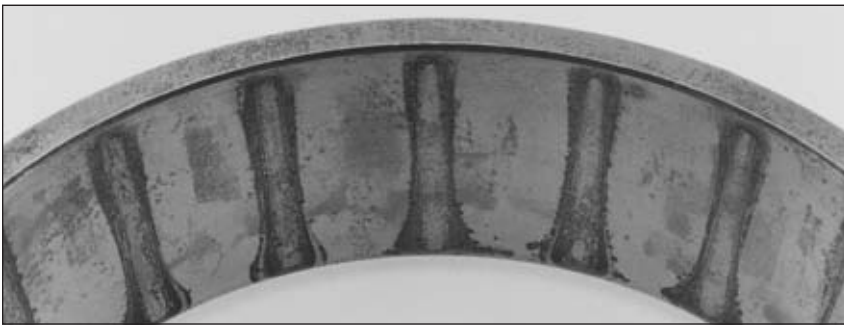

Fig. 12. This cup has heavy corrosion on the race. This type of corrosion may only be a surface stain without pitting. If the staining can be cleaned with a fine emery cloth or crocus cloth, the bearing may be reused. If there are pits that cannot be cleaned with light polishing, the bearing should either be discarded or, if practical, refurbished.

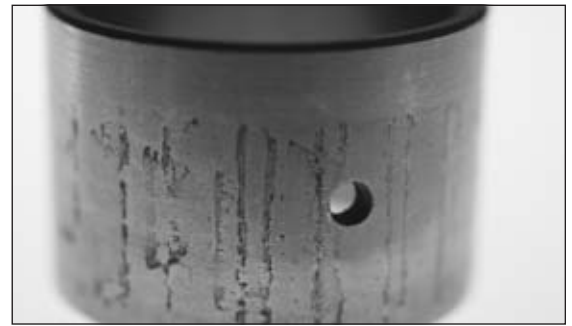

Fig. 13. This cylindrical bearing inner ring has etching and corrosion.



Fig. 14. Advanced spalling initiated at water etch marks on the cup race makes this bearing unsuitable for further service.



Fig. 15. Heavy water damage is shown on this ball bearing inner ring and cage.



Fig. 16. This ball bearing outer race also depicts etching and corrosion.

Inadequate Lubrication

Inadequate lubrication can create a wide range of damage conditions. Damage happens when there isn't a sufficient amount of bearing lubricant to separate the rolling and sliding contact surfaces during service.

It's important that the right lubricant amount, type, grade, supply system, viscosity and additives be properly engineered for each bearing system. Base your selection on history, loading, speeds, sealing systems, service conditions and expected life. Without proper consideration of these factors, you may experience less-than-expected-bearing and application performance.

The damage caused by inadequate lubrication varies greatly in both appearance and performance. Depending on the level of damage, it may range from very light heat discoloration to total bearing lockup with extreme metal flow.

The following section outlines the progressive levels of bearing damage caused by inadequate lubrication:

Level 1 – Discoloration

- Metal-to-metal contact results in excessive bearing temperature.
- High temperatures result in discoloration of the races and the roller.
- In mild cases, the discoloration is from the lubricant staining the bearing surfaces. In severe cases, the metal is discolored from high heat.

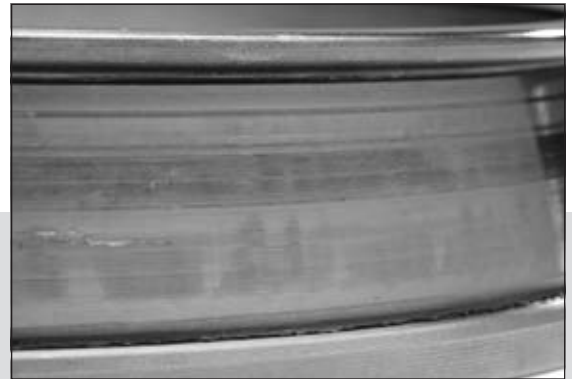

Fig. 17. Level 1 – Discoloration due to elevated operating temperatures.

Level 2 – Scoring and Peeling

- Insufficient or complete lack of lubricant.
- Selecting the wrong lubricant or lubrication type.
- Temperature changes.
- Sudden changes in running conditions.

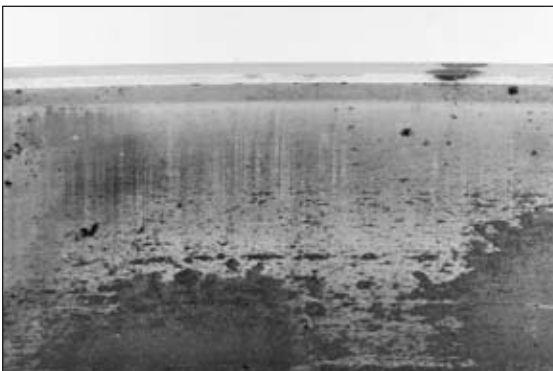

Fig. 18. Level 2 – Micro-spalling or peeling results from thin lubricant film due to high loads/low revolutions per minute (RPM) or elevated temperatures.

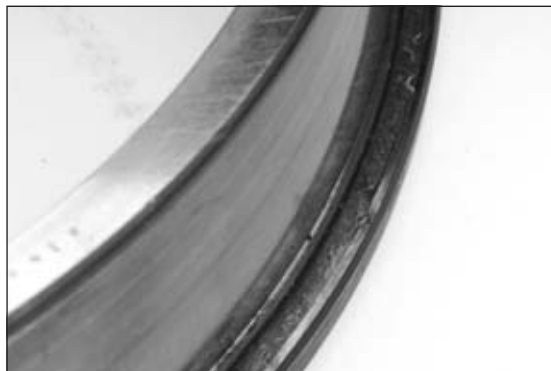

Fig. 19. Level 2 – Advanced rib scoring is due to inadequate lubricant film.

Level 3 – Excessive Roller End Heat

- Inadequate lubricant film results in localized high temperatures and scoring at the large ends of the rollers.

Fig. 20. Level 3 – Heat damage on these tapered rollers was caused by metal-to-metal contact.

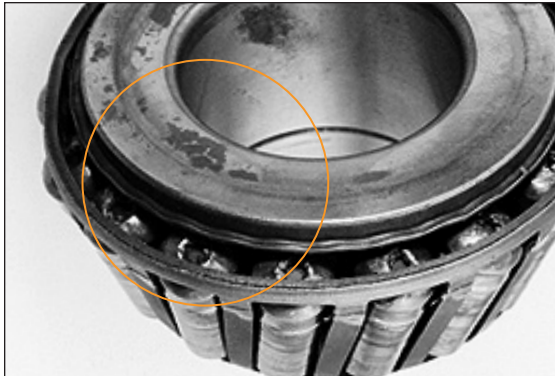
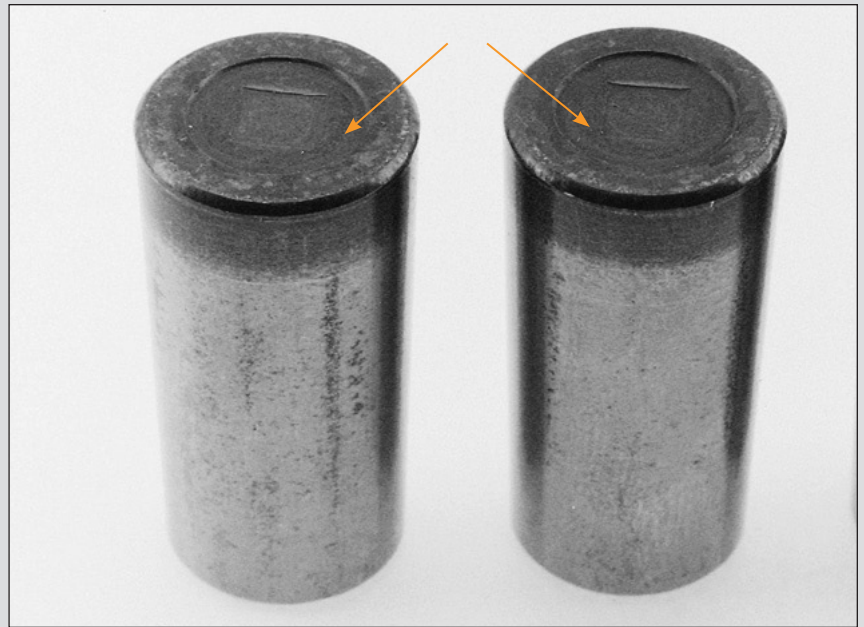

Fig. 21. Level 4 – Excessive heat generation caused advanced metal flow of the rollers, as well as cone rib deformation and cage expansion.



Fig. 22. Level 4 – This is an example of total bearing lockup.

Level 4 – Total Bearing Lockup

- High localized heat produces metal flow in bearings, altering the original bearing geometry and the bearing's material.
- This results in skewing of the rollers, destruction of the cage, metal transfer and complete seizure of the bearing.

Careful inspection of all bearings, gears, seals, lubricants and surrounding parts may help determine the primary cause of damage. See the Lubrication Reference Guide on page 23 to learn more about how lubrication conditions impact bearing performance.

Fatigue Spalling

Spalling is the pitting or flaking away of bearing material. Spalling primarily occurs on the races and the rolling elements. We show many types of “primary” bearing damage throughout this reference guide that eventually deteriorate into a secondary spalling damage mode. We classify three distinct spalling damage modes:

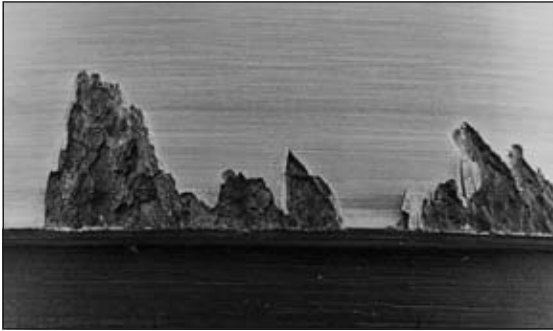

Geometric Stress Concentration (GSC) Spalling

Causes for this type of damage mode include misalignment, deflection or edge loading that initiates high stress at localized regions of the bearing. It occurs at the extreme edges of the race/roller paths. It also can be the end result of shaft or housing machining errors.

Fig. 23. Misalignment, deflections or heavy loading on this tapered roller bearing caused GSC spalling.

Point Surface Origin (PSO) Spalling

Very high and localized stress generates this type of damage mode. The spalling damage is typically from nicks, dents, debris, etching and hard-particle contamination in the bearing. It's the most common type of spalling damage, and it often appears as arrowhead-shaped spalls, propagating in the direction of rotation.

Fig. 24. PSO spalling resulted from debris or raised metal exceeding the lubricant film thickness on this tapered roller bearing inner ring.

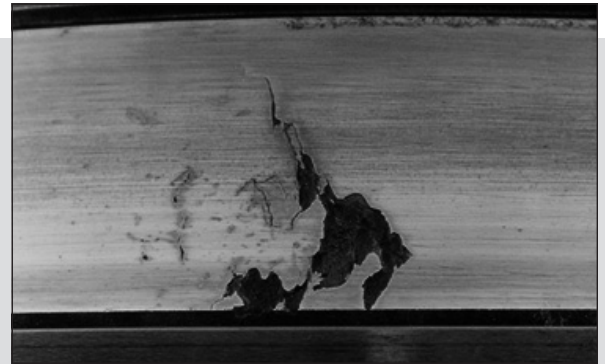

Inclusion Origin Spalling

This damage occurs when there's bearing material fatigue at localized areas of sub-surface, non-metallic inclusions following millions of load cycles. A sign of this damage appears in the form of localized, elliptically shaped spalls. Due to the improvement of bearing steel cleanliness during the past two decades, it may be unlikely you will encounter this type of spalling.

Excessive Preload or Overload

Excessive preload can generate a large amount of heat and cause damage similar in appearance to inadequate lubrication damage. Often the two causes may be confused, so you need to check the bearing thoroughly to determine the root problem. A lubricant that's suitable for normal operation may be unsuitable for a heavily preloaded bearing, as it may not have the film strength to carry the very high loads. The lubricant breakdown in high preloads can cause the same type of damage shown in the previous description of inadequate lubrication damage on page 10.

Another type of damage can result from heavy preloads even if you use a lubricant (such as an extreme pressure type of oil) that's engineered to carry heavy loads. Although the lubricant can handle the loads so that there's no rolling element or race scoring, the heavy loads may cause premature sub-surface fatigue spalling. The initiation of this spalling, and subsequently the life of the bearing, would depend on the amount of preload and the capacity of the bearing.



Fig. 25. Heavy spalling and fracturing from high loads on this spherical roller bearing.



Fig. 26. High loads resulted in fatigue spalling on this cylindrical roller bearing.

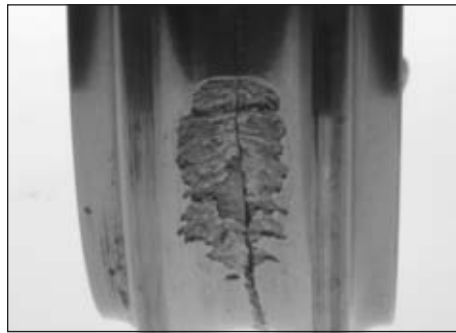

Fig. 27. This ball bearing inner ring depicts fatigue spalling from high loads. The fracture is a secondary damage mode.

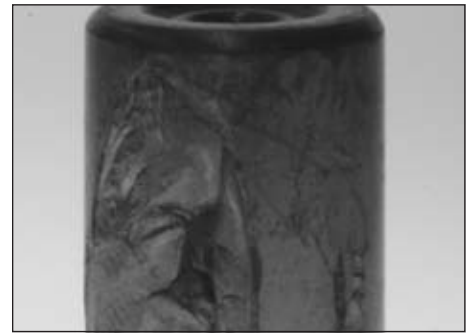

Fig. 28. Overloading on this cylindrical roller bearing caused roller surfaces to fracture.



Fig. 29. High loads and low speeds caused insufficient lubricant film on this tapered roller bearing cone.



Fig. 30. A heavily overloaded tapered roller bearing resulted in premature, severe fatigue spalling on the rollers. The load was so heavy that large pieces of metal broke off the rollers.

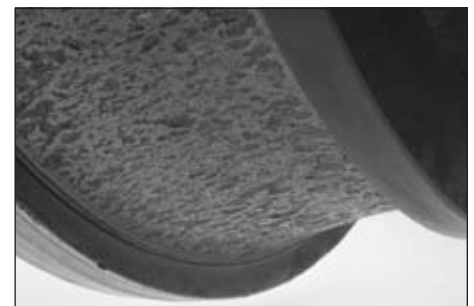

Fig. 31. This spherical roller bearing race shows severe peeling and spalling due to high loads.

Excessive Endplay

Excessive endplay results in a very small load zone and excessive looseness between the rollers and races outside the load zone. This causes the rollers to unseat, which leads to roller skidding and skewing as the rollers move into and out of the load zone. This movement creates scalloping in the cup race, and cage wear from excessive roller movement and the impact of the rollers with the raceway.



Fig. 32. Scalloping marks in the cup are common with excessive endplay. This occurs when unloaded rollers enter the small load zone and are suddenly exposed to heavy loads.



Fig. 33. Cage pocket damage results from excessive roller movement.



Fig. 34. Heavy wear in the small end of the cage pockets is typical of excessive endplay.

Misalignment and Inaccurate Seat and Shoulder Machining

Misaligned bearings will shorten bearing life. This reduction depends on the degree of misalignment. To gain more life from the bearing, the seats and shoulders supporting the bearing must be within the specified limits set by the bearing manufacturer. If the misalignment exceeds those limits, the load on the bearing won't be distributed along the rolling elements and races as intended. Instead, it will be concentrated on only a portion of the rollers or balls and races. In cases of extreme misalignment or off angle, the load will be carried only on the extreme ends of the rolling elements and races.

A heavy concentration of the load and high stresses at these points will cause early metal fatigue.

Typical causes of misalignment:

- Inaccurate machining or wear of housings or shafts.
- Deflection from high loads.
- Out-of-square backing shoulders on shafts or housings.

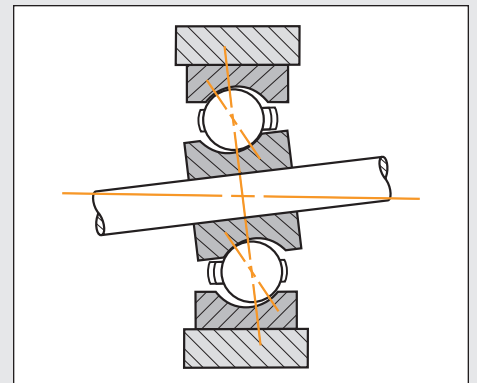

Fig. 35A. Shaft misalignment.

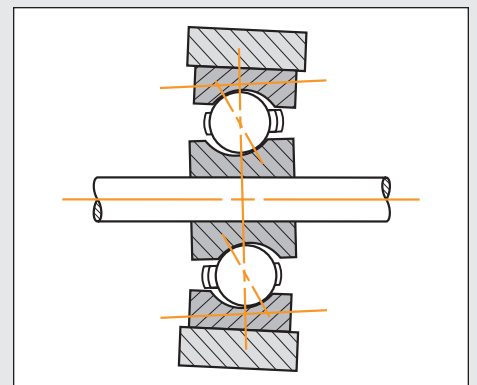

Fig. 35B. Housing misalignment.



Fig. 36. Deflection, inaccurate machining or wear of bearing seats caused an irregular roller path on this tapered roller bearing outer ring.

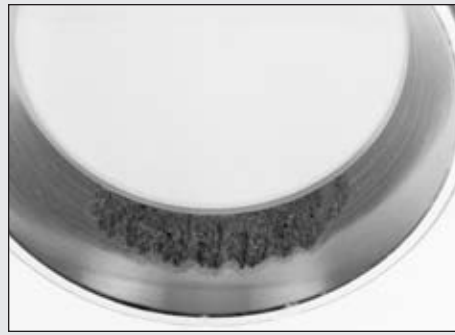

Fig. 37. This irregular roller path is 180 degrees opposite of Fig. 36.



Fig. 38. The housing bore was machined with an improper taper, causing the uneven load distribution and GSC spalling in this cylindrical roller bearing outer ring.

Handling and Installation Damage

You have to be careful when handling and assembling bearings so that you don't damage the rolling elements, race surfaces and edges. Deep gouges in the race surface or battered and distorted rolling elements will make metal rise around the gouged or damaged area. High stresses will occur as the rolling elements go over these surfaces, creating premature, localized spalling. The immediate effect of these gouges and deep nicks will be roughness, vibration and noise in the bearing.

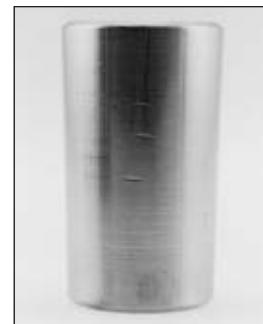

Fig. 39. Rough handling or installation damage resulted in nicks and dents in this tapered bearing roller.



Fig. 40. This spherical roller bearing inner race depicts a fractured small rib caused by the use of improper installation tools.

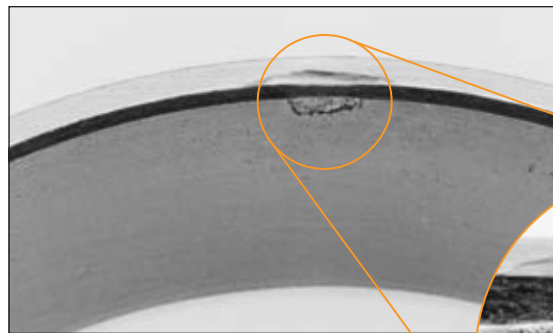

Fig. 41. A hardened driver caused cup face denting on this tapered roller bearing.

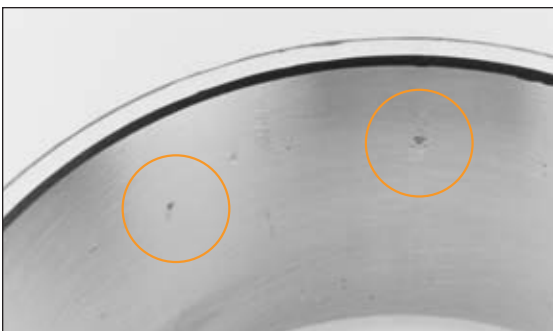

Fig. 42. Tapered roller spaced nicking was caused by the roller edges hitting the race during installation. These nicks/dents have raised edges that can lead to excessive noise, vibration or act as points of stress concentration.

Damaged Bearing Cages or Retainers

Careless handling and using improper tools during installation may cause cage or retainer damage. Cages or retainers are usually made of mild steel, bronze or brass and can be easily damaged, which can cause premature bearing performance problems.

In some applications, environmental and operating conditions can cause fractured cages or retainers. This type of damage is too complex to cover in this reference guide. If you experience this problem, contact your Timken sales or service engineer.

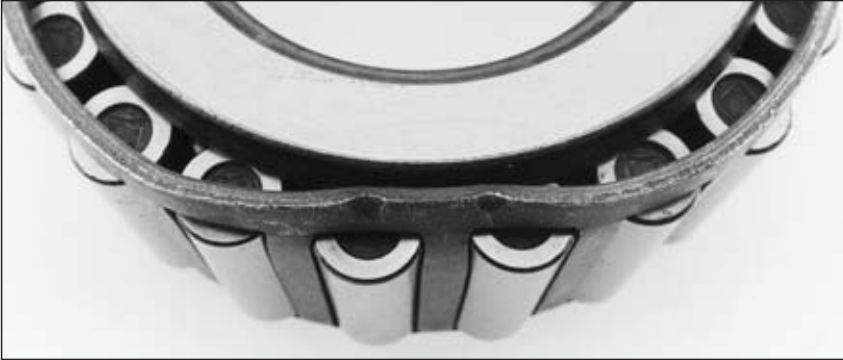

Fig. 43. This cage deformation was caused by an improperly installed or dropped bearing.



Fig. 44. Binding and skewing of these tapered rollers was due to compression of cage ring during installation or interference during service.



Fig. 45. Poor handling practices caused a deep dent on this spherical roller bearing cage bridge. This damage will result in a lack of proper roller rotation, possible roller skidding, increased temperatures and decreased life.

High Spots and Fitting Practices

Careless handling or damage caused when driving outer races out of housings or wheel hubs can create burrs or high spots in the outer race seats. If a tool gouges the housing seat surface, it will leave raised areas around the gouge. If you don't scrape or grind down these high spots before reinstalling the outer race, the high spot will transfer through the outer race and cause a corresponding high spot in the outer race's inside diameter. Stresses increase when the rolling elements hit this high area, which can result in lower than predicted service life.



Fig. 46. A worn-out housing caused this bearing to lose fit and fret (move) during service. As a result, metal tearing and wear occurred on this spherical outer ring.

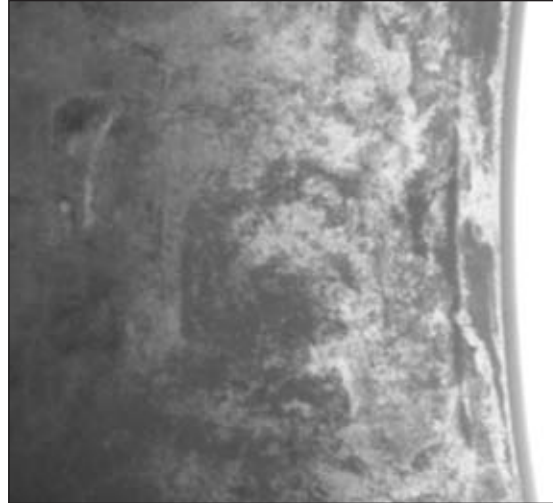

Fig. 47. Classic fretting corrosion from poor fitting practice is depicted here. Relative movement under load between the bearing and its seat caused this worn and corroded condition.



Fig. 48. The marks on the outside diameter of this cup race are caused by a high spot on the housing. The cup race is spalled at the spot that corresponds to the spot on the outside of the cup marked from heavy contact.

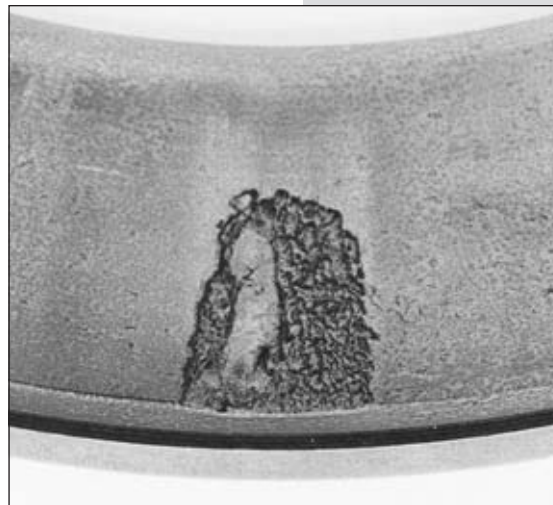

Fig. 49. Localized spalling on this cup race resulted from a stress riser created by a split housing pinch point.

Improper Fit in Housings or Shafts

Follow the manufacturer's recommended bearing fit to ensure your bearings perform properly.

In general, you should apply the bearing race – where the rotating load exists – with a press or tight fit. An example is a wheel hub, where the outer race should be applied with a press fit. The races on a stationary axle would normally be applied with a light or loose fit. Where the shaft rotates, the inner race should normally be applied with a press fit and the outer race may be applied with a split fit or even a loose fit, depending on the application.

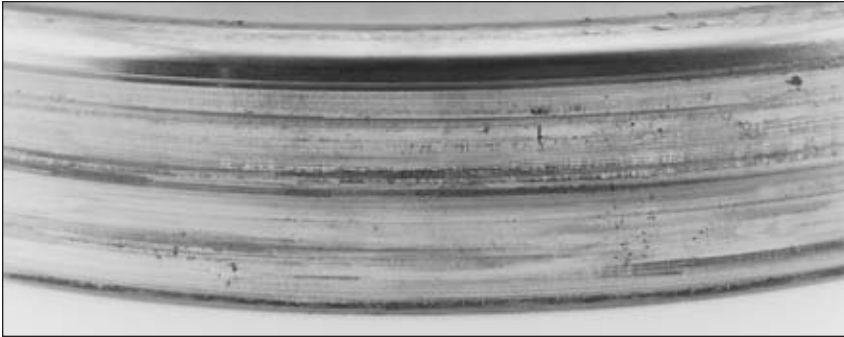

Fig. 50. A loose cup fit in a rotating wheel hub (typically tight) caused this bearing race damage.

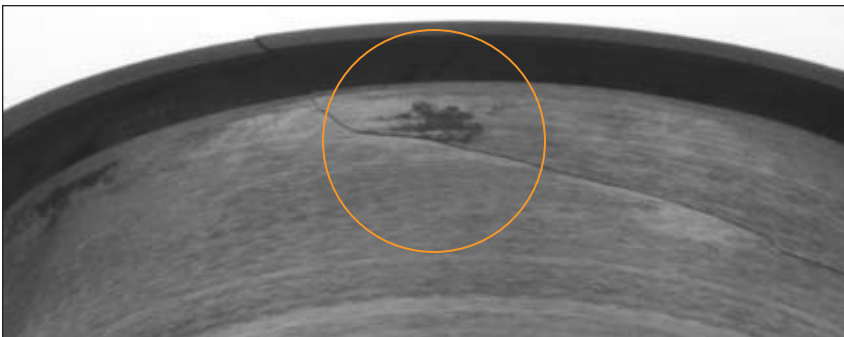

Fig. 52. This ball bearing inner ring fracture results from installation on top of a metal contaminant or raised metal nick.



Fig. 53. An out-of-round or oversized shaft caused this fracture on a tapered roller bearing cone.

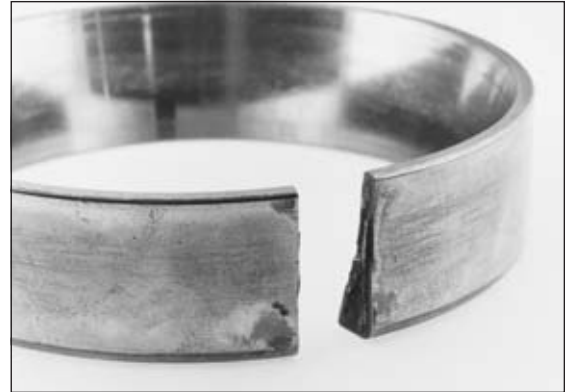

Fig. 51. This is what happens to a cup that is loose in a wheel hub. The cup turns and wears the cup seat so the fit becomes more loose. Then the cup starts to stretch or roll out. The cup, as it rolls out, continues to wear the cup seat and the cup continues to stretch. This process continues to the point where the stretch of the metal reaches the breaking point and the cup cracks open.

Brinell and Impact Damage

Improper mounting and disassembly methods and/or extremely high operational impact or static loads may cause brinelling.

Brinell from improper assembly and disassembly happens when a force gets applied against the unmounted race. When mounting a bearing on a shaft with a tight fit, pushing the outer race will exert an excessive thrust load and bring the rolling elements into sharp contact with the race, causing brinell.

Fig. 55A shows incorrect removal of a bearing, while Fig. 55B shows the correct way to mount or dismount a bearing by applying the force to the tight-fitted race.

Extremely heavy impact loads, which may be short in duration, can result in brinell of the bearing races. Sometimes, they can even fracture the races and rolling elements.

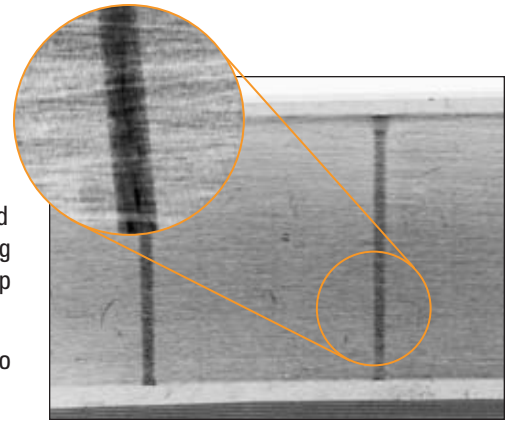

Fig. 54. A heavy impact load on this tapered bearing cup race caused brinell and impact damage. These same indentations are evident on the cone race. This is true metal deformation and not wear as with false brinelling. The close-up view of one of the grooves shows the grinding marks still in the groove.

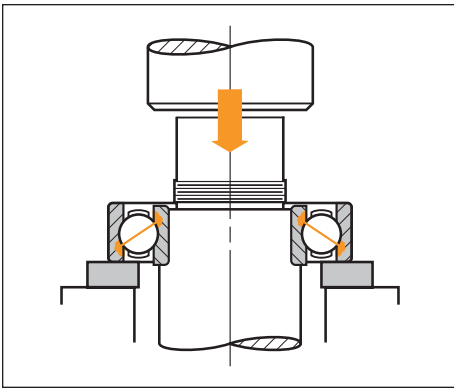

Fig. 55A. Incorrect.

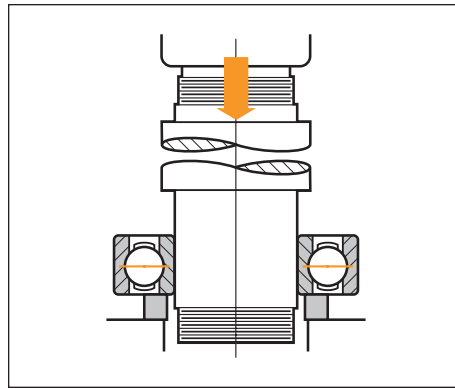

Fig. 55B. Correct.

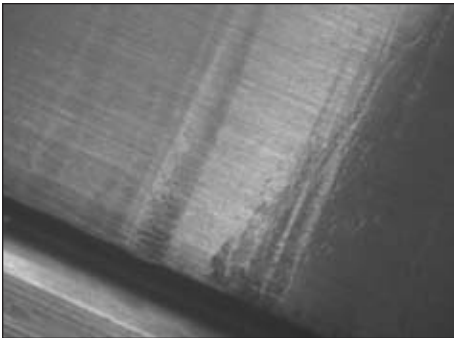

Fig. 56. This inner ring of a spherical roller bearing shows roller impact damage from shock loading.

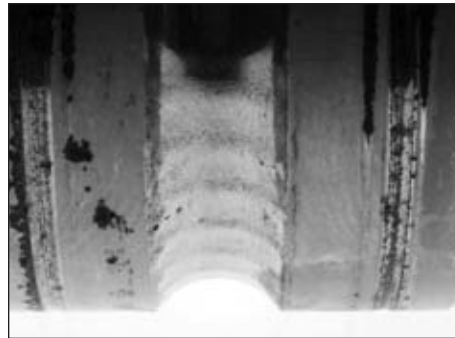

Fig. 57. Note shock loading caused brinell damage on this ball bearing inner ring.

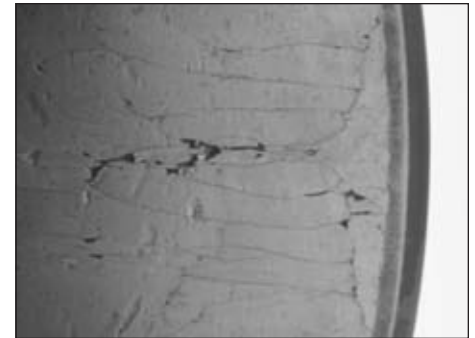

Fig. 58. This cylindrical roller bearing inner ring was crushed by an application failure during service.

False Brinelling

As the name indicates, false brinelling isn't true brinelling or denting. It's actually fretting wear caused by slight axial rolling-element movements while the bearing is stationary. Vibration can make the rolling element slide back and forth across the race, wearing a groove into the race.

There are times when this can't be prevented, such as when automobiles or other types of equipment are shipped by rail, truck or ocean freight for relatively long distances. The vibration may cause enough movement to generate false brinelling. It can be greatly reduced or eliminated by reducing the potential for relative movement and decreasing the static weight present during shipment or storage.

Roller bearings also exhibit false brinelling when they're used in positions that encounter very small reversing angular oscillation (less than one complete rotation of the rolling element).

You can distinguish false brinelling from true brinelling by examining the depression or wear area. False brinelling will actually wear away the surface texture, whereas the original surface texture will remain in the depression of a true brinell.

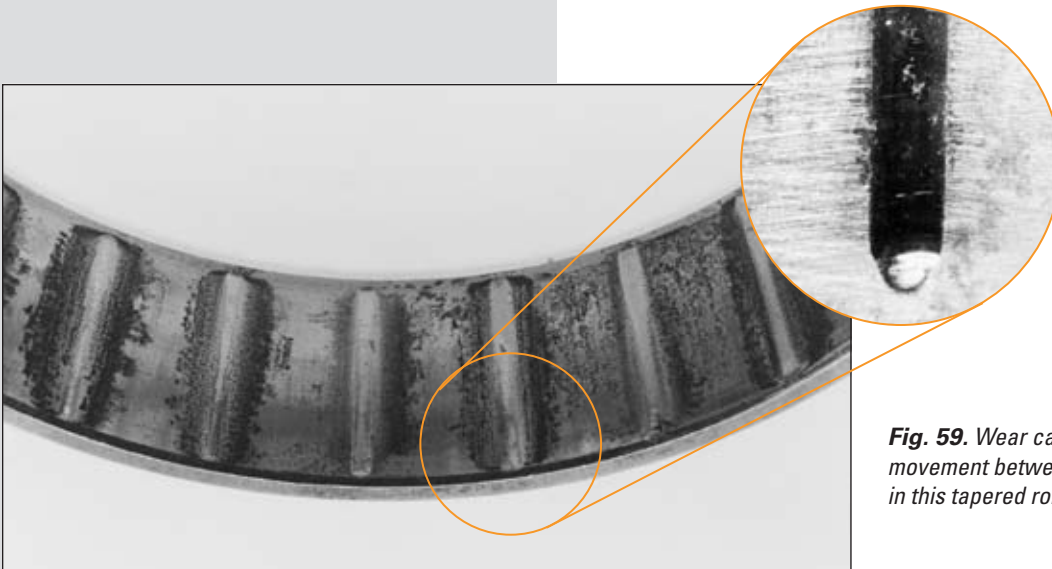

Fig. 59. Wear caused by vibration or relative axial movement between the rollers and races is depicted in this tapered roller bearing outer ring.

Burns from Electric Current

Arcing, which produces high temperatures at localized points, occurs when an electric current that passes through a bearing is broken at the contact surfaces between the races and rolling elements. Each time the current is broken while passing between the ball or roller and race, it produces a pit on both parts. Eventually fluting develops. As it becomes deeper, it creates noise and vibration. A high-amperage current, such as a partial short circuit, will cause a rough, granular appearance. Heavy jolts of high-amperage charges will cause more severe damage, welding metal from the race to the ball or roller. These metal protrusions on the roller will, in turn, cause a crater effect in the race, generating more noise and vibration.

Causes of arcing include static electricity from charged belts or processes that use calendar rolls, faulty wiring, improper grounding, welding, inadequate or defective insulation, loose rotor windings on an electric motor and short circuits.

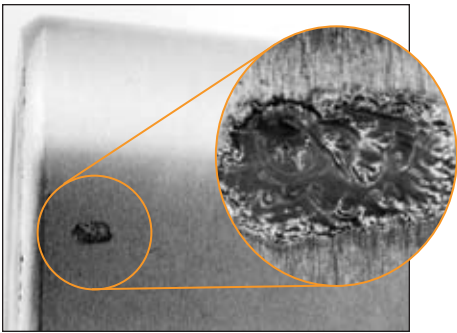

Fig. 60. Electric arc pitting or small burns, magnified 10X here, were created by arcs from improper electric grounding while the bearing was stationary.

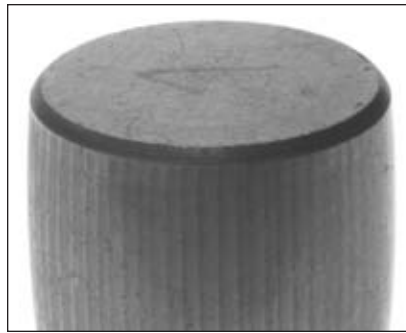

Fig. 61. Welding on a machine, while the bearings were rotating, caused electric arc fluting on this spherical roller bearing.

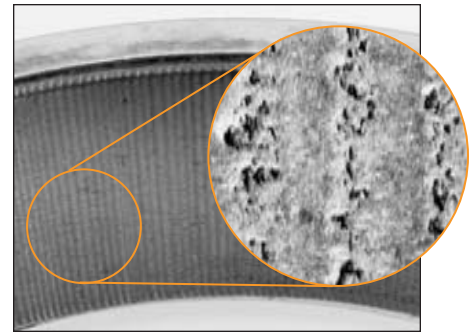

Fig. 62. Magnified 10X, this fluting, defined as a series of small axial burns, was caused by an electric current passing through the bearing while it was rotating.

Cam Fracture

Cam Fracture: Wide Inner Ring Ball Bearings

An undersized shaft or an outer ring that cannot be aligned due to the housing may cause a broken cam, a misaligned travel path or bearing wobble.

This type of bearing damage may be prevented by using the correct size shaft and by using the Timken self-aligning feature, a spherical outer ring to compensate for initial misalignment and correctly mount bearings.

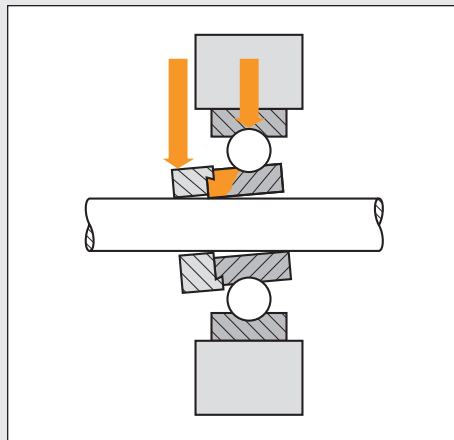

Fig. 63A. Shaft below suggested tolerance levels.

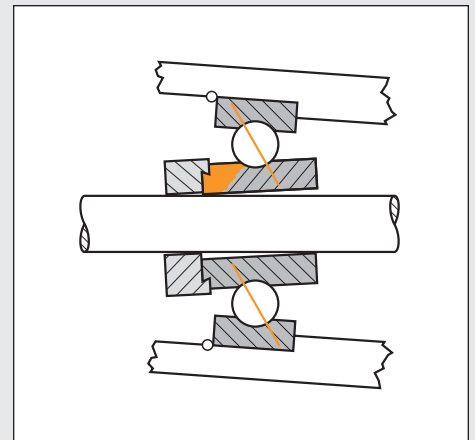

Fig. 63B. Misaligned outer ring.

Understanding Bearing Life

Bearing Service Life

Bearing service life is based on many factors. Depending on the application requirements, the actual service life can greatly vary. For example, a machine tool spindle bearing may be unfit for further service because of minor wear that affects spindle accuracy. In contrast, a rolling mill roll neck bearing may have a satisfactory service life even if the bearing developed spalling damage, as long as the spalls are properly repaired in a timely fashion.

Reduced service life can be caused either individually or by any combination of:

- Faulty mounting.
- Improper adjustment.
- Insufficient lubrication.
- Contamination.
- Improper or abusive handling.
- Poor housing support.
- High-static misalignment or shaft and housing deflection.
- Poor or inconsistent maintenance practices.

The life of your bearing also depends on the load zone obtained under operating conditions. Generally speaking, the greater the load zone, the longer the life of the bearing under stabilized operating conditions.

Fig. 64 illustrates this relationship for tapered roller bearings; other roller bearings with radial loads possess a similar performance relationship.

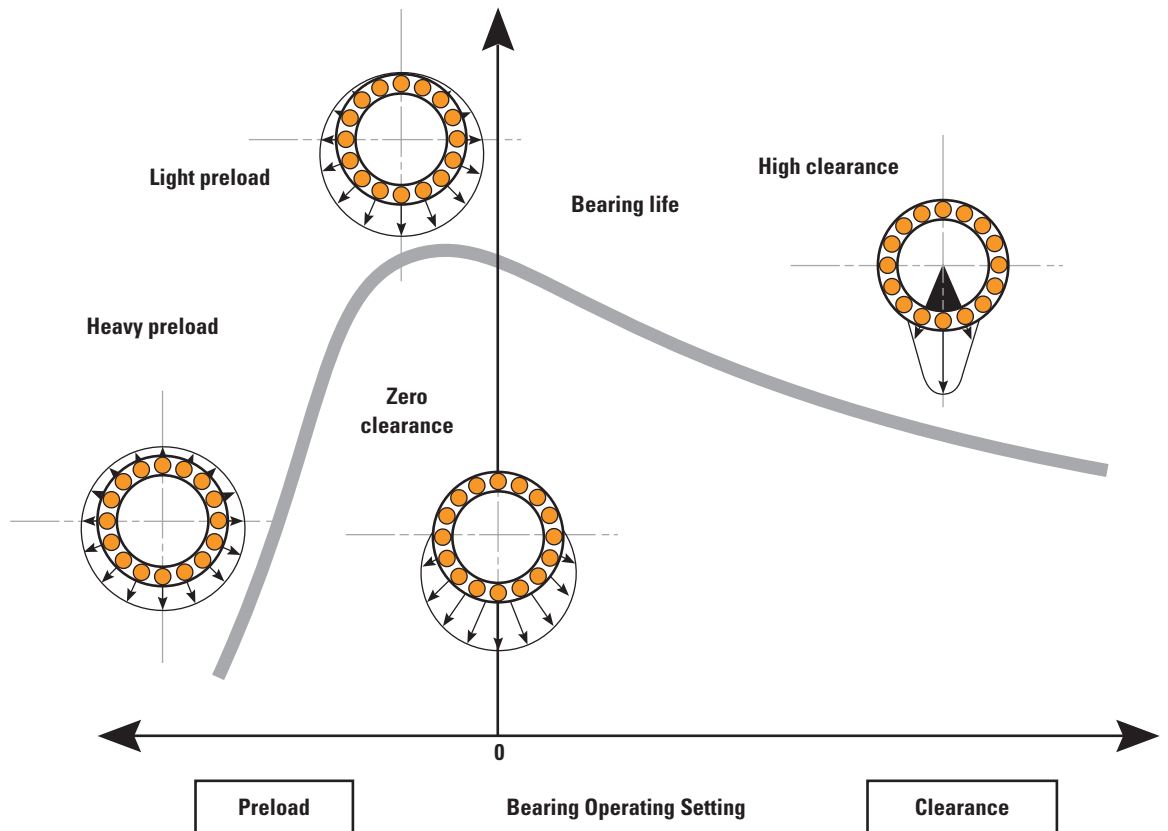

Fig. 64. Bearing life vs. bearing operating setting.

Lubrication Reference Guide

Factors that Impact Lubrication Performance

As we explained on page 10, the life of a Timken® bearing depends on the proper bearing lubrication. Grease lubricants help protect surfaces against corrosion while reducing friction.

Inadequate lubrication causes a high percentage of bearing damage. Although it's a broad term, we classify "inadequate lubrication" into these basic categories:

- Overfilling.
- Underfilling.
- Incorrect grease.
- Mixing greases.
- Worn-out grease.
- Water contamination.
- Incorrect lubrication systems and intervals.

Overfilling

Overfilling a bearing with too much grease can cause excess churning and high temperatures during operation. This can create overheating and excess grease purging (leaking) – see note below. Overheating happens when the generated heat can't dissipate correctly, continually building until damage occurs. As the bearing's operating temperature rises, the oxidation (breakdown) rate of the grease sharply increases – doubling every 10° C (18° F).



Fig. 66. "Clean" grease slightly purging (leaking) from a bearing during initial start-up is generally acceptable. The grease is wet and evenly purged. If this slight purge is not causing any problems, leave it alone as it is an effective barrier seal.



Fig. 65. This petri dish above contains heavily oxidized grease, which purged from an overfilled bearing. Grease undergoing heavy oxidation often has a very distinguishable black color and burned odor. In addition, it gets stiffer in consistency.

NOTE

During initial start-up, it is common for a properly greased bearing to purge a small amount of grease. A slight grease purge is often recommended by original equipment manufacturers, as it acts as a barrier seal to help keep out external debris contamination (Fig. 66). Always follow original equipment manufacturers' recommendations regarding grease purging and correct replenishment amounts.

An overfilled bearing may also purge grease during initial start-up. However, over time and as temperature rises, excess grease will continue to purge from an overfilled bearing and have a darkened color (Fig. 65).



Underfilling

Underfilling a bearing with grease also can have adverse consequences. As in overfilling, underfilling can generate heat but for different reasons. A low amount of grease can create a condition known as a grease starvation, which causes heat generation or excessive metal wear during operation. If a bearing suddenly becomes noisy and/or the temperature increases, excessive wear may be taking place.

Fig. 67. Grease removed from an underfilled bearing shows shiny bearing metal debris.

Incorrect Grease

The base oil in a particular grease may have a different thickness (viscosity) than what's recommended for your application. If the base oil viscosity is too heavy, the rolling elements may have difficulty pushing through the grease and begin to skid (Fig. 68). If this happens, excessive grease oxidation (breakdown) (Fig. 69A) may cause premature grease degeneration and excessive wear of bearing components. If the viscosity is too light, the thin lubricant film from the higher temperatures may cause peeling (micro-spalling) and wear (Fig. 69B). Additionally, the additives contained in a particular grease may be inappropriate or even incompatible with the surrounding components in your system.



Fig. 68. This cylindrical roller flattened as a result of skidding

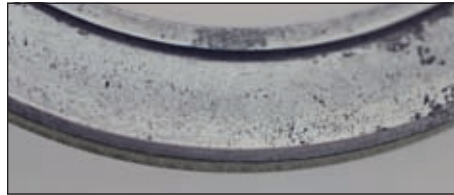

Fig. 69A.

Micro-spalling in a tapered roller bearing outer race (Fig. 69A) and inner race (Fig. 69B) was due to thin lubricant film.

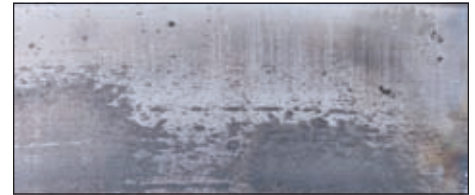
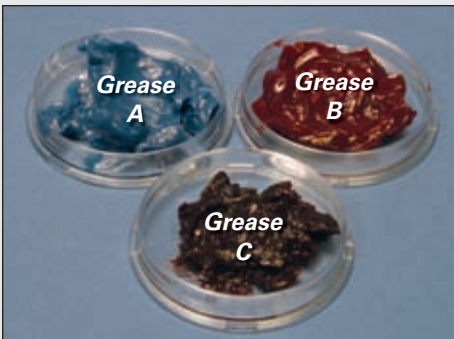

Fig. 69B.



Mixing Greases

A bearing should run well with the correct grease. When performing routine maintenance, make sure that you lubricate the bearing with the same type of grease or a compatible substitute. If you use an incompatible grease, or one with the wrong consistency, this new mixture may:

1. Soften and leak out of the bearing because of the incompatibility of the grease thickener.
2. Become lumpy, discolored and hard (Fig. 70).

Fig. 70. Grease A and Grease B are not compatible. When mixed together they become lumpy, discolored and hard in composition (Grease C).

Worn-Out Grease

Grease is a precise combination of additives, oil and thickener (Fig. 71). It acts like a sponge to retain and release the oil. Time and temperature conditions can deplete oil release properties. When this occurs, the grease is worn-out (Fig. 72).

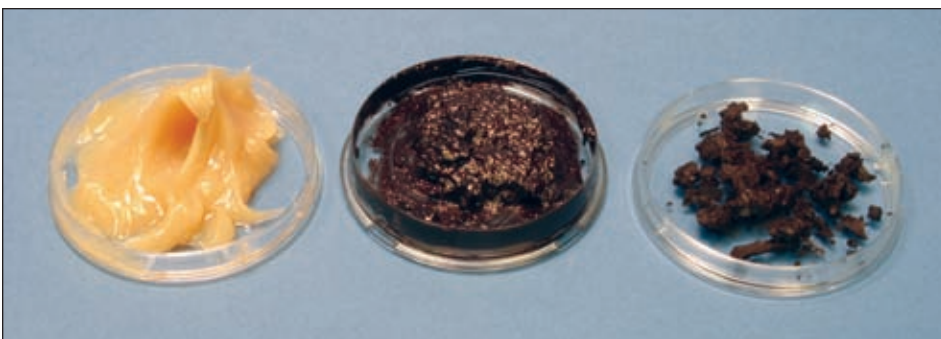

Fig. 72. The above photo shows the same grease at three stages from left to right. 1) new grease, 2) heavily oxidized grease, and 3) worn-out (failed) grease where the thickener and additives have decomposed and the oil has broken down.



Fig. 71. Grease is a precise combination of additives, oil and thickener.



Incorrect Lubrication Systems and Intervals

To help prevent bearing components from wearing prematurely, it's critical to maintain the correct bearing lubrication systems and intervals.

If you don't follow maintenance schedules, excessive oxidation may cause the lubrication to deteriorate.

Fig. 73. A technician records key bearing lubrication data on a maintenance sheet.

Water Contamination

Fig. 74 shows the effect of water on grease by comparing fresh grease to a grease emulsified with 30 percent water. The fresh grease is smooth and buttery compared to the water-laden grease, which has a milky white appearance. The presence of as little as 1 percent water in grease can make a significant impact on bearing life.

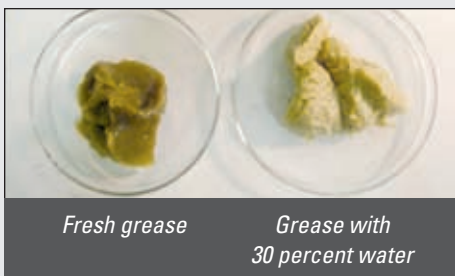

Fig. 74. The effect of water on grease is depicted here.



Fig. 75. A tapered roller bearing cone and rollers, and a ball bearing outer race and balls (Fig. 76) show rusting with pitting and corrosion from moisture/water exposure.



Fig. 76.

Quick and Easy Field Test to Determine Water in Grease

An easy, non-quantified method of determining the presence of water in grease is known as the crackle test. To perform this test, place a grease sample on a piece of aluminum foil (Fig. 77) and put a flame under the foil (Fig. 78). If the grease melts and lightly smokes, the presence of water is minimal. However, if the grease crackles, sizzles and/or pops, the grease contains a considerable amount of water.



Fig. 77. To perform a crackle test, first put the grease sample on a piece of aluminum foil.



Fig. 78. A crackle test determines the presence of water in grease.

WARNING

Failure to observe the following warnings could create a risk of serious injury.

Heated grease or water may create a risk of burns or eye damage. Wear suitable personal protective clothing, including eye protection and gloves, when performing this test.

Lubrication Guidelines

Required Grease Quantity

To avoid the generation of heat, the bearing must not be over greased. The required quantity of grease is based on the free volume of the bearing calculated as follows:

$$V = \pi/4 (D^2 - d^2) (T) - M/A$$

Where:

V = free volume in the bearing (mm³ – in.³)

D = outer race O.D. (mm – in.)

d = inner race bore (mm – in.)

T = overall width (mm – in.)

M = bearing weight (kg – lb)

A = average steel density
7.8 x 10⁻⁶ kg / mm³ 0.283 lb / in.³

π = 3.1416

Grease should be packed into the bearing so that it gets between the rolling elements – the rollers or balls. For tapered roller bearings, forcing grease through the bearing from the large end to the small end will ensure proper distribution. Special recommendations apply to sealed bearing assemblies. Contact a Timken sales or service engineer for more information.

Consult the original equipment manufacturer for all lubricant information.

Grease Compatibility Chart

	Al Complex	Ba Complex	Ca Stearate	Ca 12 Hydroxy	Ca Complex	Ca Sulfonate	Clay Non-Soap	Li Stearate	Li 12 Hydroxy	Li Complex	Polyurea	Polyurea S S
Aluminum Complex	Best Choice	Compatible	Compatible	Compatible	Compatible	Borderline	Compatible	Compatible	Compatible	Compatible	Compatible	Compatible
Timken Food Safe	Best Choice	Compatible	Compatible	Compatible	Compatible	Borderline	Compatible	Compatible	Compatible	Compatible	Compatible	Compatible
Barium Complex	Compatible	Best Choice	Compatible	Compatible	Compatible	Compatible	Compatible	Compatible	Compatible	Compatible	Compatible	Borderline
Calcium Stearate	Compatible	Compatible	Best Choice	Compatible	Compatible	Compatible	Compatible	Compatible	Compatible	Borderline	Compatible	Compatible
Calcium 12 Hydroxy	Compatible	Compatible	Compatible	Best Choice	Compatible	Borderline	Compatible	Compatible	Compatible	Compatible	Compatible	Compatible
Calcium Complex	Compatible	Compatible	Compatible	Compatible	Best Choice	Compatible	Compatible	Compatible	Compatible	Compatible	Compatible	Compatible
Calcium Sulfonate	Borderline	Compatible	Compatible	Compatible	Compatible	Best Choice	Compatible	Compatible	Compatible	Compatible	Compatible	Compatible
Timken Premium Mill Timken Heavy Duty Moly	Borderline	Compatible	Compatible	Compatible	Compatible	Best Choice	Compatible	Compatible	Compatible	Compatible	Compatible	Compatible
Clay Non-Soap	Compatible	Compatible	Compatible	Compatible	Compatible	Compatible	Best Choice	Compatible	Compatible	Compatible	Compatible	Borderline
Lithium Stearate	Compatible	Compatible	Compatible	Compatible	Compatible	Compatible	Compatible	Best Choice	Compatible	Compatible	Compatible	Compatible
Lithium 12 Hydroxy	Compatible	Compatible	Borderline	Compatible	Compatible	Compatible	Compatible	Compatible	Best Choice	Compatible	Compatible	Compatible
Lithium Complex	Compatible	Compatible	Compatible	Compatible	Compatible	Compatible	Compatible	Compatible	Compatible	Best Choice	Compatible	Compatible
Polyurea Conventional	Compatible	Compatible	Compatible	Compatible	Compatible	Compatible	Compatible	Compatible	Compatible	Compatible	Best Choice	Compatible
Polyurea Shear Stable	Compatible	Borderline	Compatible	Compatible	Compatible	Compatible	Compatible	Compatible	Compatible	Compatible	Compatible	Best Choice
Timken Multi-Use	Compatible	Compatible	Borderline	Compatible	Compatible	Compatible	Compatible	Compatible	Best Choice	Compatible	Compatible	Compatible
Timken All-Purpose Timken Synthetic	Compatible	Compatible	Compatible	Compatible	Compatible	Compatible	Compatible	Compatible	Compatible	Best Choice	Compatible	Compatible
Timken Pillow Block	Compatible	Borderline	Compatible	Compatible	Compatible	Compatible	Compatible	Compatible	Compatible	Compatible	Compatible	Best Choice

WARNING

Failure to observe the following warning could create a risk of death or serious injury.

Mixing greases can result in improper bearing lubrication. Always follow the specific lubrication instructions of your equipment supplier.

Glossary

Abrasive Wear

Usually occurs when foreign particles cut the bearing surfaces.

Adhesive Wear

Caused by metal-to-metal contact, resulting in scuffing or scoring of the bearing surfaces.

Angular Contact Ball Bearing

Ball bearing whose internal clearance and race location result in predetermined angle of contact.

Axial Endplay

The total relative measurable axial displacement of the shaft to the housing in a system of two angular contact bearings, such as angular contact ball bearings or tapered roller bearings.

Axial Internal Clearance

In radial bearing types, total maximum permissible axial displacement (parallel to bearing axis) of inner ring relative to outer ring.

Axial Load

Load acting in direction parallel with bearing axis. Also known as thrust.

Brinelling

A dent or depression in the bearing raceway due to extremely high-impact or static loads.

Brinelling – False

Wear grooves in the raceway caused by minute movement or vibration of the rolling elements while the bearing is stationary.

Bruising

The denting or plastic indentation in the raceways and rolling elements due to the contamination of foreign particles in the bearing.

Etching – Corrosion

Usually caused by moisture or water contamination and can vary from light staining to deep pitting.

Fatigue

The fracture and breaking away of metal in the form of a spall. Generally, there are three modes of contact fatigue recognized:

- Geometric stress concentration.
- Point surface origin.
- Inclusion origin.

Fillet Radius

Shaft or housing corner dimension that bearing corner must clear.

Fixed Bearing

Bearing which positions shaft against axial movement in both directions.

Floating Bearing

Bearing so designed or mounted as to permit axial displacement between shaft and housing.

Fluting

Electro-etching on both the inner and outer ring.

Fretting Corrosion

Usually occurs on the bores, outside diameters and faces of bearing races due to minute movement of these surfaces and the shaft or housing. Red or black oxide of iron is usually evident.

Housing Fit

Amount of interference or clearance between bearing outside surface and housing bearing seat.

Life

The theoretical bearing life expectancy of a group of bearings can be calculated from the operating conditions and the bearing load rating based on material fatigue. These calculations must assume that the bearings are correctly mounted, adjusted, lubricated and otherwise properly handled.

Continued

Glossary continued

Misalignment

A bearing mounted condition whereby the centerline of the inner race is not aligned with the centerline of the outer race. Lack of parallelism between axis of rotating member and stationary member is a cause of misalignment, as are machining errors of the housing/shaft, deflection due to high loads, and excessive operating clearances.

Preload

The absence of endplay or internal clearance. All of the rolling elements are in contact or in compression with the inner and outer races or cups and cones. Internal load on the rolling elements of bearing, which is the result of mounting conditions or design. Can be intentional or unintentional.

Radial Internal Clearance

In radial bearing types, the total maximum possible radial displacement (perpendicular to bearing axis) of inner ring relative to outer ring.

Radial Load

Load acting in direction perpendicular with bearing axis.

Scoring

Caused by metal-to-metal contact, resulting in the removal and transfer of metal from one component of a bearing to another. Various degrees of scoring can be described as scuffing, smearing, sliding, galling or any other sliding motion.

Shaft Fit

Amount of interference or clearance between bearing inside diameter and shaft bearing seat outside diameter.

Spalling – Flaking

A breaking away of metal on the raceway or rolling elements in flake or scale-like particles.

Types of Bearings and Nomenclature

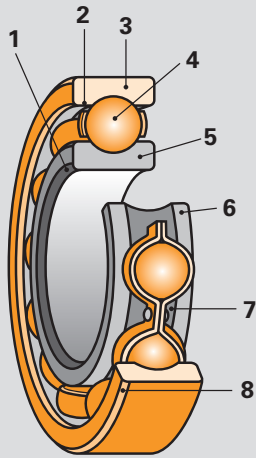

Radial Ball Bearing

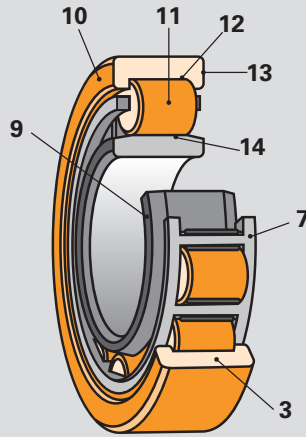

Cylindrical Roller Bearing

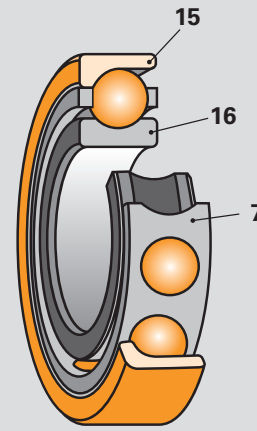

Angular Contact Ball Bearing

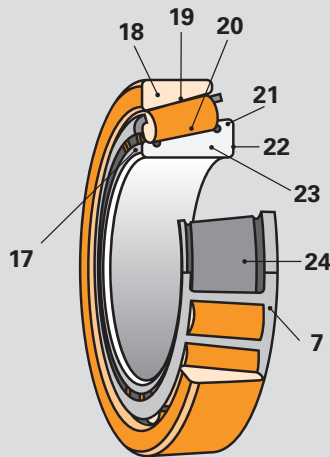

Tapered Roller Bearing

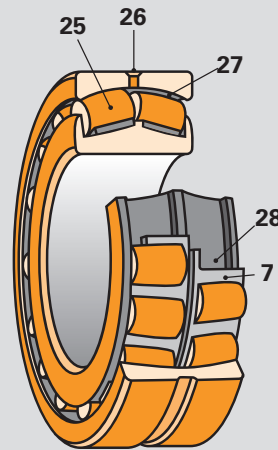

Spherical Roller Bearing

Bearing Nomenclature Key

- | | | |
|-----------------------------|------------------------|--|
| 1. Inner Ring Corner Radius | 11. Cylindrical Roller | 21. Cone Large Rib |
| 2. Outer Ring Land | 12. Outer Ring Race | 22. Cone Back Face |
| 3. Outer Ring | 13. Outer Ring Face | 23. Cone (Inner Ring) |
| 4. Ball | 14. Inner Ring Race | 24. Cone Race |
| 5. Inner Ring | 15. Counter Bore | 25. Spherical Roller |
| 6. Inner Ring Land | 16. Thrust Face | 26. Lubrication Feature (Holes and Groove) |
| 7. Cage | 17. Cone Front Face | 27. Spherical Outer Ring Race |
| 8. Outer Ring Corner Radius | 18. Cup (Outer Ring) | 28. Spherical Inner Ring Race |
| 9. Inner Ring Face | 19. Cup Race | |
| 10. Outer Ring Face | 20. Tapered Roller | |

Tapered Roller Bearing Speed Capability Guidelines

Speed Capability Guidelines

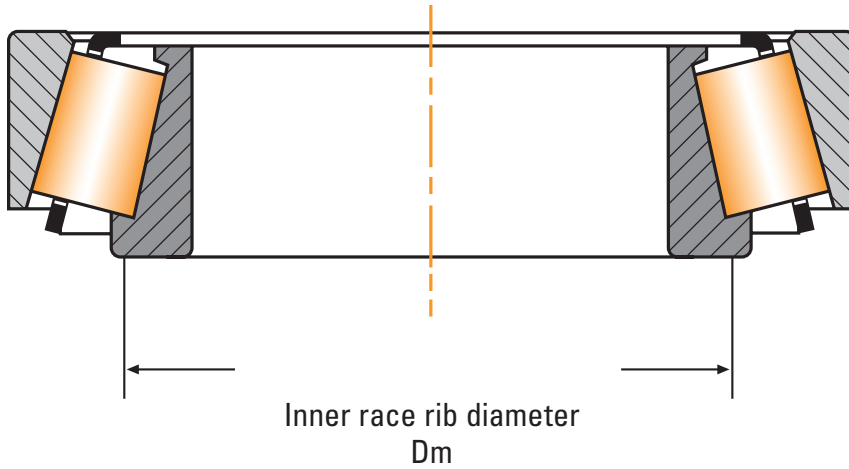

Rib speed:
 $V_r = \pi D_m n / 60000$ (m/s)
 $V_r = \pi D_m n / 12$ (ft/min)

Where:
 D_m = Inner race rib diameter (mm, in.)
 n = Bearing speed (rev/min)
 π = 3.1416

Fig. 79. The inner race rib diameter can be scaled from a drawing or can be approximated as the average of the bearing inner and outer diameter.

Speed Capability Guidelines for Various Types of Lubrication Systems

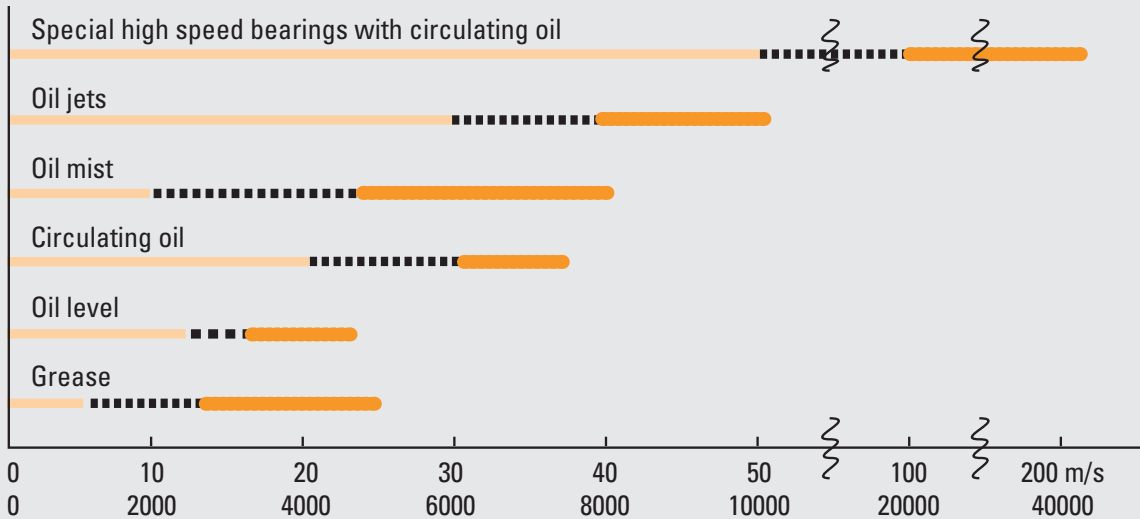

- Typical industry experience indicates no problems under ordinary circumstances.
- - - Industry experience indicates testing may be required to optimize system.
- Testing will be needed and special bearings may be required to achieve these speeds.

Fig. 80. Here, we summarize guidelines relating to speed and temperature based on customer experience, customer tests and research conducted by The Timken Company. Consult your Timken engineer with questions regarding high-speed capability.

Temperature Guidelines for Roller Bearing Installation

Temperature Guidelines

Maximum and minimum temperatures, as well as maximum time-at-temperature limits, have been established to prevent metallurgical transformation of steel components and potential, detrimental physical changes in seals or non-metallic components. During the manufacturing process, bearing rings and rolling elements are heat treated to define the strength, hardness and dimensional stability for proper operation. Heating or cooling bearings or bearing components beyond these limits may affect performance.

These suggestions are merely guidelines and, as new data is developed, the values as shown may change. These guidelines do not cover all Timken products.

Heating

- These are the maximum temperature limits.
- For elastomer or polymer seals or cages, only use hot air as a heating medium.
- Protect exposed bearing/ring surfaces after positioning on the shaft or housing, and as they normalize to ambient temperatures.

Standard Class Bearings or Rings (with metallic cages and without seals)

Includes Class 4, 2, K, N, ABEC-1 and ABEC-3.
121° C (250° F) 8 Hours

Standard Class Bearings or Rings (with non-metallic cages and polymer or elastomer seals)

Special considerations may apply for phenolic cages or special fluorocarbon lip seals.
93° C (200° F) 24 Hours

Precision and Super Precision Class Bearings and Rings

Include Class 3, 0, 00, 000, C, B, A, ABEC 5, 7, 9.
66° C (150° F) 24 Hours

Cooling (Freezing)

- These are the minimum temperature limits.
- To prevent corrosion:
 - Before installation, remove frost from all surfaces.
 - After installation and during part warming, remove moisture condensation.
 - Wipe surfaces with clean, lint-free cloth and reapply preservative.

Freezing Standard Class Bearings and Rings

-54° C (-65° F) 1 Hour
This temperature can be obtained using dry ice in an alcohol bath.

Freezing Precision Class Outer Rings or Cups

-29° C (-20° F) 2 Hours
This temperature can be obtained by commercial freezer/refrigeration equipment.

 **WARNING**

Failure to observe the following warnings could create a risk of serious injury.

Proper maintenance and handling procedures are critical. Always follow installation and maintain proper lubrication.

Cone Bore Growth Expansion Rates Due to Thermal Changes

Thermal growth of components can be calculated using the formula:
 $d \times T \times \alpha = \text{Thermal Growth}$

Where:

d = bearing bore diameter

T = maximum bearing temperature after heating minus ambient temperature

α = coefficient of linear expansion: $11 \times 10^{-6} / ^\circ\text{C}$ ($6.1 \times 10^{-6} / ^\circ\text{F}$) for ferrous metal shaft and housing materials

Cone Bore	Thermometer Temperature Reading in Degrees		
	65° C 150° F	90° C 200° F	120° C 250° F
mm in.	mm in.	mm in.	mm in.
25.4 1	0.012 0.0005	0.020 0.0008	0.027 0.0011
50.8 2	0.025 0.0010	0.040 0.0016	0.055 0.0022
76.2 3	0.036 0.0014	0.058 0.0023	0.081 0.0032
101.6 4	0.048 0.0019	0.078 0.0031	0.109 0.0043
127 5	0.061 0.0024	0.099 0.0039	0.137 0.0054
152.4 6	0.073 0.0029	0.119 0.0047	0.165 0.0065
177.8 7	0.086 0.0034	0.139 0.0055	0.193 0.0076
203.2 8	0.096 0.0038	0.157 0.0062	0.218 0.0086
228.6 9	0.109 0.0043	0.177 0.0070	0.246 0.0097
254 10	0.121 0.0048	0.198 0.0078	0.274 0.0108
279.4 11	0.134 0.0053	0.218 0.0086	0.302 0.0119
304.8 12	0.147 0.0058	0.238 0.0094	0.330 0.0130
330 13	0.157 0.0062	0.256 0.0101	0.355 0.0140
355.6 14	0.170 0.0067	0.276 0.0109	0.383 0.0151
381 15	0.182 0.0072	0.297 0.0117	0.411 0.0162
406.4 16	0.195 0.0077	0.317 0.0125	0.439 0.0173
431.8 17	0.208 0.0082	0.337 0.0133	0.467 0.0184
457.2 18	0.218 0.0086	0.355 0.0140	0.492 0.0194

Cone Bore	Thermometer Temperature Reading in Degrees		
	65° C 150° F	90° C 200° F	120° C 250° F
mm in.	mm in.	mm in.	mm in.
482.6 19	0.231 0.0091	0.375 0.0148	0.520 0.0205
508 20	0.243 0.0096	0.396 0.0156	0.548 0.0216
533.4 21	0.256 0.0101	0.416 0.0164	0.576 0.0227
558.8 22	0.269 0.0106	0.436 0.0172	0.604 0.0238
584.2 23	0.279 0.0110	0.454 0.0179	0.629 0.0248
609.6 24	0.292 0.0115	0.475 0.0187	0.657 0.0259
635 25	0.304 0.0120	0.495 0.0195	0.685 0.0270
660.4 26	0.317 0.0125	0.515 0.0203	0.713 0.0281
685.8 27	0.330 0.0130	0.535 0.0211	0.741 0.0292
711.2 28	0.340 0.0134	0.553 0.0218	0.767 0.0302
736.6 29	0.353 0.0139	0.574 0.0226	0.795 0.0313
762 30	0.365 0.0144	0.594 0.0234	0.823 0.0324
787.4 31	0.378 0.0149	0.614 0.0242	0.850 0.0335
812.8 32	0.391 0.0154	0.635 0.0250	0.878 0.0346
838.2 33	0.401 0.0158	0.652 0.0257	0.904 0.0356
863.6 34	0.414 0.0163	0.673 0.0265	0.932 0.0367
889 35	0.426 0.0168	0.693 0.0273	0.960 0.0378
914.4 36	0.439 0.0173	0.713 0.0281	0.988 0.0389

Calculations are based on an ambient temperature of 21° C (70° F).

Conversion Equivalents for U.S. and Metric Measurements

Viscosity Conversion Table

SUS Saybolt	R in. Redwood	E Engler	cSt Centistokes
sec.	sec.	deg.	mm ² /s
35	32.2	1.18	2.7
40	36.2	1.32	4.3
45	40.6	1.46	5.9
50	44.9	1.60	7.4
55	49.1	1.75	8.9
60	53.5	1.88	10.4
65	57.9	2.02	11.8
70	62.3	2.15	13.1
75	67.6	2.31	14.5
80	71.0	2.42	15.8
85	75.1	2.55	17.0
90	79.6	2.68	18.2
95	84.2	2.81	19.4
100	88.4	2.95	20.6
110	97.1	3.21	23.0
120	105.9	3.49	25.0
130	114.8	3.77	27.5
140	123.6	4.04	29.8
150	132.4	4.32	32.1
160	141.1	4.59	34.3
170	150.0	4.88	36.5
180	158.8	5.15	38.8
190	167.5	5.44	41.0
200	176.4	5.72	43.2
220	194.0	6.28	47.5
240	212	6.85	51.9
260	229	7.38	56.5
280	247	7.95	60.5
300	265	8.51	64.9
325	287	9.24	70.3
350	309	9.95	75.8
375	331	10.7	81.2
400	353	11.4	86.8
425	375	12.1	92.0
450	397	12.8	97.4
475	419	13.5	103
500	441	14.2	108
550	485	15.6	119
600	529	17.0	130
650	573	18.5	141
700	617	19.9	152
750	661	21.3	163
800	705	22.7	173
850	749	24.2	184
900	793	25.6	195
950	837	27.0	206
1000	882	28.4	217
1200	1058	34.1	260
1400	1234	39.8	302
1600	1411	45.5	347
1800	1587	51	390
2000	1763	57	433
2500	2204	71	542
3000	2646	85	650
3500	3087	99	758
4000	3526	114	867
4500	3967	128	974
5000	4408	142	1082
5500	4849	156	1150
6000	5290	170	1300
6500	5730	185	1400
7000	6171	199	1510
7500	6612	213	1630
8000	7053	227	1740
8500	7494	242	1850
9000	7934	256	1960
9500	8375	270	2070
10000	8816	284	2200

To Convert From	To	Multiply By
Acceleration		
foot/second ²	meter/second ²	m/s ² 0.3048
inch/second ²	meter/second ²	m/s ² 0.0254
Area		
foot ²	meter ²	m ² 0.09290304
inch ²	meter ²	m ² 0.00064516
inch ²	millimeter ²	mm ² 645.16
yard ²	meter ²	m ² 0.836127
mile ² (U.S. statute)	meter ²	m ² 2589988
Bending Moment or Torque		
dyne-centimeter	newton-meter	N-m 0.0000001
kilogram-force-meter	newton-meter	N-m 9.806650
pound-force-inch	newton-meter	N-m 0.1129848
pound-force-foot	newton-meter	N-m 1.355818
Energy		
BTU (International Table)	joule	J 1055.056
foot-pound-force	joule	J 1.355818
kilowatt-hour	megajoule	MJ 3.6
Force		
kilogram-force	newton	N 9.806650
kilopound-force	newton	N 9.806650
pound-force (lbf avoirdupois)	newton	N 4.448222
Length		
fathom	meter	m 1.8288
foot	m	m 0.3048
inch	millimeter	mm 25.4
microinch	micrometer	µm 0.0254
micron (µm)	millimeter	mm 0.0010
mile (U.S. statute)	meter	m 1609.344
yard	meter	m 0.9144
nautical mile (UK)	meter	m 1853.18
Mass		
kilogram-force-second ² /meter (mass)	kilogram	kg 9.806650
kilogram-mass	kilogram	kg 1.0
pound-mass (lbf avoirdupois)	kilogram	kg 0.4535924
ton (long, 2240 lbf)	kilogram	kg 1016.047
ton (short, 2000 lbf)	kilogram	kg 907.1847
tonn	kilogram	kg 1000.000
Power		
BTU (International Table)/hour	watt	W 0.293071
BTU (International Table)/minute	watt	W 17.58427
horsepower (550 ft lbf/s)	kilowatt	kW 0.745700
BTU (thermochemical)/minute	watt	W 17.57250
Pressure or Stress (Force/Area)		
newton/meter ²	pascal	Pa 1.0000
kilogram-force/centimeter ²	pascal	Pa 98066.50
kilogram-force/meter ²	pascal	Pa 9.806650
kilogram-force/millimeter ²	pascal	Pa 9806650
pound-force/foot ²	pascal	Pa 47.88026
pound-force/inch ² (psi)	megapascal	MPa 0.006894757
Temperature		
degree Celsius	kelvin	k $t_k = t_c + 273.15$
degree Fahrenheit	kelvin	k $k = \frac{5}{9}(t_f + 459.67)$
degree Fahrenheit	Celsius	°C $t_c = \frac{5}{9}(t_f - 32)$
Velocity		
foot/minute	meter/second	m/s 0.00508
foot/second	meter/second	m/s 0.3048
inch/second	meter/second	m/s 0.0254
kilometer/hour	meter/second	m/s 0.27778
mile/hour (U.S. statute)	meter/second	m/s 0.44704
mile/hour (U.S. statute)	kilometer/hour	km/h 1.609344
Volume		
foot ³	meter ³	m ³ 0.02831685
gallon (U.S. liquid)	liter	l 3.785412
liter	meter ³	m ³ 0.001
inch ³	meter ³	m ³ 0.00001638706
inch ³	centimeter ³	cm ³ 16.38706
inch ³	millimeter ³	mm ³ 16387.06
ounce (U.S. fluid)	centimeter ³	cm ³ 29.57353
yard ³	meter ³	m ³ 0.7645549

Conversion Chart Showing Millimeter, Fractional and Decimal Inch Sizes

Fractional	Dec. Equiv.	mm	Fractional	Dec. Equiv.	mm	Fractional	Dec. Equiv.	mm	Fractional	Dec. Equiv.	mm	Fractional	Dec. Equiv.	mm
1/4 in.	.0039	0.10	3/4 in.	.0689	1.75	1 1/4 in.	.1570	—	3/2 in.	.2677	6.80	7/16 in.	.4219	10.72
	.0059	0.15		.0700	—		.1575	4.00		.2716	6.90		.4330	11.00
	.0079	0.20		.0709	1.80		.1590	—		.2720	—		.4375	11.11
	.0098	0.25		.0728	1.85		.1610	—		.2756	7.00		.4528	11.50
	.0118	0.30		.0730	—		.1614	4.10		.2770	—		.4531	11.51
	.0135	—		.0748	1.90		.1654	4.20		.2795	7.10		.4687	11.91
	.0138	0.35		.0760	—		.1660	—		.2811	—		.4724	12.00
	.0145	—		.0767	1.95		.1673	4.25		.2812	7.14		.4843	12.30
	.0156	0.39		.0781	1.98		.1693	4.30		.2835	7.20		.4921	12.50
	.0157	0.40		.0785	—		.1695	—		.2854	7.25		.5000	12.70
	.0160	—		.0787	2.00		.1719	4.37		.2874	7.30		.5118	13.00
	.0177	0.45		.0807	2.05		.1730	—		.2900	—		.5156	13.10
	.0180	—		.0810	—		.1732	4.40		.2913	7.40		.5312	13.49
	.0197	0.50		.0820	—		.1770	—		.2950	—		.5315	13.50
	.0200	—		.0827	2.10		.1771	4.50		.2953	7.50		.5469	13.89
	.0210	—		.0846	2.15		.1800	—		.2968	7.54		.5512	14.00
.0217	0.55	.0860	—	.1811	4.60	.2992	7.60	.5625	14.29					
.0225	—	.0866	2.20	.1820	—	.3020	—	.5709	14.50					
.0236	0.60	.0885	2.25	.1850	4.70	.3031	7.70	.5781	14.68					
.0240	—	.0890	—	.1870	4.75	.3051	7.75	.5906	15.00					
.0250	—	.0905	2.30	.1875	4.76	.3071	7.80	.5937	15.08					
.0256	0.65	.0925	2.35	.1890	4.80	.3110	7.90	.6094	15.48					
.0260	—	.0935	—	.1910	—	.3125	7.94	.6102	15.50					
.0280	—	.0937	2.38	.1929	4.90	.3150	8.00	.6250	15.88					
.0276	0.70	.0945	2.40	.1935	—	.3160	—	.6299	16.00					
.0292	—	.0960	—	.1960	—	.3189	8.10	.6406	16.27					
.0295	0.75	.0964	2.45	.1968	5.00	.3228	8.20	.6496	16.50					
.0310	—	.0980	—	.1990	—	.3230	—	.6562	16.67					
.0312	0.79	.0984	2.50	.2008	5.10	.3248	8.25	.6693	17.00					
.0315	0.80	.0995	—	.2010	—	.3268	8.30	.6719	17.06					
.0320	—	.1015	—	.2031	5.16	.3281	8.33	.6875	17.46					
.0330	—	.1024	2.60	.2040	—	.3307	8.40	.6890	17.50					
.0335	0.85	.1040	—	.2047	5.20	.3320	—	.7031	17.86					
.0350	—	.1063	2.70	.2055	—	.3346	8.50	.7087	18.00					
.0354	0.90	.1065	—	.2067	5.25	.3386	8.60	.7187	18.26					
.0360	—	.1082	2.75	.2086	5.30	.3390	—	.7283	18.50					
.0370	—	.1094	2.78	.2090	—	.3425	8.70	.7344	18.65					
.0374	0.95	.1100	—	.2126	5.40	.3437	8.73	.7480	19.00					
.0380	—	.1102	2.80	.2130	—	.3445	8.75	.7500	19.05					
.0390	—	.1110	—	.2165	5.50	.3465	8.80	.7656	19.45					
.0394	1.0	.1130	—	.2187	5.56	.3480	—	.7677	19.50					
.0400	—	.1141	2.90	.2205	5.60	.3504	8.90	.7812	19.84					
.0410	—	.1160	—	.2210	—	.3543	9.00	.7874	20.00					
.0413	1.05	.1181	3.00	.2244	5.70	.3580	—	.7969	20.24					
.0420	—	.1200	—	.2263	5.75	.3583	9.10	.8071	20.50					
.0430	—	.1220	3.10	.2280	—	.3594	9.13	.8125	20.64					
.0433	1.10	.1250	3.18	.2283	5.80	.3622	9.20	.8268	21.00					
.0452	1.15	.1260	3.20	.2323	5.90	.3641	9.25	.8281	21.03					
.0465	—	.1279	3.25	.2340	—	.3661	9.30	.8437	21.43					
.0469	1.19	.1285	—	.2344	5.95	.3680	—	.8465	21.50					
.0472	1.20	.1299	3.30	.2362	6.00	.3701	9.40	.8594	21.83					
.0492	1.25	.1338	3.40	.2380	—	.3740	9.50	.8661	22.00					
.0512	1.30	.1360	—	.2401	6.10	.3750	9.53	.8750	22.23					
.0520	—	.1378	3.50	.2420	—	.3770	—	.8858	22.50					
.0531	1.35	.1405	—	.2441	6.20	.3780	9.60	.8906	22.62					
.0550	—	.1406	3.57	.2460	6.25	.3819	9.70	.9055	23.00					
.0551	1.40	.1417	3.60	.2480	6.30	.3838	9.75	.9062	23.02					
.0570	1.45	.1440	—	.2500	6.35	.3858	9.80	.9219	23.42					
.0591	1.50	.1457	3.70	.2520	6.40	.3860	—	.9252	23.50					
.0595	—	.1470	—	.2559	6.50	.3898	9.90	.9375	23.81					
.0610	1.55	.1476	3.75	.2570	—	.3906	9.92	.9449	24.00					
.0625	1.59	.1495	—	.2598	6.60	.3937	10.00	.9531	24.21					
.0629	1.60	.1496	3.80	.2610	—	.3970	—	.9646	24.50					
.0635	—	.1520	—	.2638	6.70	.4040	—	.9687	24.61					
.0649	1.65	.1535	3.90	.2656	6.75	.4062	10.32	.9843	25.00					
.0669	1.70	.1540	—	.2657	6.75	.4130	—	.9844	25.03					
.0670	—	.1562	3.97	.2660	—	.4134	10.50	1.000	25.40					

Temperature Conversion Table

This conversion table can be used to convert temperature to Celsius (°C) or to Fahrenheit (°F). The center column is the base temperature. If you want to convert from °F to °C, you would look up the number in the center column and the number in the left column would show the conversion in °C. To convert °C to °F, you would look up the base number and the conversion to °F is shown in the right column.

As an example, to find the °F for 100° C, look up 100 in the base temperature column. The column to the right shows +212° F as the conversion. The shaded portions of the chart represent negative values.

Base Temp.			Base Temp.			Base Temp.			Base Temp.			Base Temp.		
°C	°F or °C	°F	°C	°F or °C	°F	°C	°F or °C	°F	°C	°F or °C	°F	°C	°F or °C	°F
-73.33	-100	-148.0	-1.11	30	86.0	40.56	105	221.0	148.89	300	572	357.22	675	1247
70.55	95	139.0	0.56	31	87.8	41.11	106	222.8	151.67	305	581	360.00	680	1256
67.78	90	130.0	0.00	32	89.6	41.67	107	224.6	154.44	310	590	362.78	685	1265
65.00	85	121.0	0.56	33	91.4	42.22	108	226.4	157.22	315	599	365.56	690	1274
62.22	80	112.0	1.11	34	93.2	42.78	109	228.2	160.00	320	608	368.34	695	1283
59.44	75	103.0	1.67	35	95.0	43.33	110	230.0	162.78	325	617	371.11	700	1292
56.67	70	94.0	2.22	36	96.8	43.89	111	231.8	165.56	330	626	373.89	705	1301
53.89	65	85.0	2.78	37	98.6	44.44	112	233.6	168.33	335	635	376.67	710	1310
51.11	60	76.0	3.33	38	100.4	45.00	113	235.4	171.11	340	644	379.44	715	1319
48.33	55	67.0	3.89	39	102.2	45.56	114	237.2	173.89	345	653	382.22	720	1328
45.56	50	58.0	4.44	40	104.0	46.11	115	239.0	176.67	350	662	385.00	725	1337
44.44	48	54.4	5.00	41	105.8	46.67	116	240.8	179.44	355	671	387.78	730	1346
43.33	46	50.8	5.56	42	107.6	47.22	117	242.6	182.22	360	680	390.56	735	1355
42.22	44	47.2	6.11	43	109.4	47.78	118	244.4	185.00	365	689	393.33	740	1364
41.11	42	43.6	6.67	44	111.2	48.33	119	246.2	187.78	370	698	396.11	745	1373
40.00	40	40.0	7.22	45	113.0	48.87	120	248.0	190.56	375	707	398.89	750	1382
38.89	38	36.4	7.78	46	114.8	49.44	121	249.8	193.33	380	716	401.67	755	1391
37.78	36	32.8	8.33	47	116.6	50.00	122	251.6	196.11	385	725	404.44	760	1400
36.67	34	29.2	8.89	48	118.4	50.56	123	253.4	198.89	390	734	407.22	765	1409
35.56	32	25.6	9.44	49	120.2	51.11	124	255.2	201.67	395	743	410.00	770	1418
34.44	30	22.0	10.00	50	122.0	51.67	125	257.0	204.44	400	752	412.78	775	1427
33.33	28	18.4	10.56	51	123.8	52.22	126	258.8	207.22	405	761	415.56	780	1436
32.22	26	14.8	11.11	52	125.6	52.78	127	260.6	210.00	410	770	418.33	785	1445
31.11	24	11.2	11.67	53	127.4	53.33	128	262.4	212.78	415	779	421.11	790	1454
30.00	22	7.6	12.22	54	129.2	53.89	129	264.2	215.56	420	788	423.89	795	1463
28.89	20	4.0	12.78	55	131.0	54.44	130	266.0	218.33	425	797	426.67	800	1472
28.33	19	2.2	13.33	56	132.8	55.00	131	267.8	221.11	430	806	429.44	805	1481
27.78	18	0.4	13.89	57	134.6	55.56	132	269.6	223.89	435	815	432.22	810	1490
27.22	17	1.4	14.44	58	136.4	56.11	133	271.4	226.67	440	824	435.00	815	1499
26.67	16	3.2	15.00	59	138.2	56.67	134	273.2	229.44	445	833	437.78	820	1508
26.11	15	5.0	15.56	60	140.0	57.22	135	275.0	232.22	450	842	440.56	825	1517
25.56	14	6.8	16.11	61	141.8	57.78	136	276.8	235.00	455	851	443.33	830	1526
25.00	13	8.6	16.67	62	143.6	58.33	137	278.6	237.78	460	860	446.11	835	1535
24.44	12	10.4	17.22	63	145.4	58.89	138	280.4	240.56	465	869	448.89	840	1544
23.89	11	12.2	17.78	64	147.2	63.44	139	282.2	243.33	470	878	451.67	845	1553
23.33	10	14.0	18.33	65	149.0	60.00	140	284.0	246.11	475	887	454.44	850	1562
22.78	9	15.8	18.89	66	150.8	60.56	141	285.8	248.89	480	896	457.22	855	1571
22.22	8	17.6	19.44	67	152.6	61.11	142	287.6	251.67	485	905	460.00	860	1580
21.67	7	19.4	20.00	68	154.4	61.67	143	289.4	254.44	490	914	462.78	865	1589
21.11	6	21.2	20.56	69	156.2	62.22	144	291.2	257.22	495	923	465.56	870	1598
20.56	5	23.0	21.11	70	158.0	62.78	145	293.0	260.00	500	932	468.33	875	1607
20.00	4	24.8	21.67	71	159.8	63.33	146	294.8	262.78	505	941	471.11	880	1616
19.44	3	26.6	22.22	72	161.6	63.89	147	296.6	265.56	510	950	473.89	885	1625
18.89	2	28.4	22.78	73	163.4	64.44	148	298.4	268.33	515	959	476.67	890	1634
18.33	1	30.2	23.33	74	165.2	65.00	149	300.2	271.11	520	968	479.44	895	1643
17.78	0	32.0	23.89	75	167.0	65.56	150	302.0	273.89	525	977	482.22	900	1652
17.22	1	33.8	24.44	76	168.8	66.11	151	311.0	276.67	530	986	485.00	905	1661
16.67	2	35.6	25.00	77	170.6	71.11	160	320.0	279.44	535	995	487.78	910	1670
16.11	3	37.4	25.56	78	172.4	73.89	165	329.0	282.22	540	1004	490.56	915	1679
15.56	4	39.2	26.11	79	174.2	76.67	170	338.0	285.00	545	1013	493.33	920	1688
15.00	5	41.0	26.67	80	176.0	79.44	175	347.0	287.78	550	1022	496.11	925	1697
14.44	6	42.8	27.22	81	177.8	82.22	180	356.0	290.56	555	1031	498.89	930	1706
13.89	7	44.6	27.78	82	179.6	85.00	185	365.0	293.33	560	1040	501.67	935	1715
13.33	8	46.4	28.33	83	181.4	87.78	190	374.0	296.11	565	1049	504.44	940	1724
12.78	9	48.2	28.89	84	183.2	90.56	195	383.0	298.89	570	1058	507.22	945	1733
12.22	10	50.0	29.44	85	185.0	93.33	200	392.0	301.67	575	1067	510.00	950	1742
11.67	11	51.8	30.00	86	186.8	96.11	205	401.0	304.44	580	1076	512.78	955	1751
11.11	12	53.6	30.56	87	188.6	98.89	210	410.0	307.22	585	1085	515.56	960	1760
10.56	13	55.4	31.11	88	190.4	101.67	215	419.0	310.00	590	1094	518.33	965	1769
10.00	14	57.2	31.67	89	192.2	104.44	220	428.0	312.78	595	1103	521.11	970	1778
9.44	15	59.0	32.22	90	194.0	107.22	225	437.0	315.56	600	1112	523.89	975	1787
8.89	16	60.8	32.78	91	195.8	110.00	230	446.0	318.33	605	1121	526.67	980	1796
8.33	17	62.6	33.33	92	197.6	112.78	235	455.0	321.11	610	1130	529.44	985	1805
7.78	18	64.4	33.89	93	199.4	115.56	240	464.0	323.89	615	1139	532.22	990	1814
7.22	19	66.2	34.44	94	201.2	118.33	245	473.0	326.67	620	1148	535.00	995	1823
6.67	20	68.0	35.00	95	203.0	121.11	250	482.0	329.44	625	1157	537.78	1000	1832
6.11	21	69.8	35.56	96	204.8	123.89	255	491.0	332.22	630	1166	540.56	1005	1841
5.56	22	71.6	36.11	97	206.6	126.67	260	500.0	335.00	635	1175	543.33	1010	1850
5.00	23	73.4	36.67	98	208.4	129.44	265	509.0	337.78	640	1184	546.11	1015	1859
4.44	24	75.2	37.22	99	210.2	132.22	270	518.0	340.56	645	1193	548.89	1020	1868
3.89	25	77.0	37.78	100	212.0	135.00	275	527.0	343.33	650	1202	551.67	1025	1877
3.33	26	78.8	38.33	101	213.8	137.78	280	536.0	346.11	655	1211	554.44	1030	1886
2.78	27	80.6	38.89	102	215.6	140.56	285	545.0	348.89	660	1220	557.22	1035	1895
2.22	28	82.4	39.44	103	217.4	143.33	290	554.0	351.67	665	1229	560.00	1040	1904
1.67	29	84.2	40.00	104	219.2	146.11	295	563.0	354.44	670	1238	562.78	1045	1913

Timken Bearing Solutions



Tapered Roller Bearings

Not all bearings will face unforgiving conditions like huge payloads or high-contaminant environments. But when they do, Timken tapered roller bearings can handle the burden – with thousands of combinations in single-, double- and four-row configurations to manage both radial and thrust loads. Customized geometries, engineered surfaces and sealed versions can further enhance performance.

- Increased power density means more performance in a smaller, lighter bearing
- Rated among the highest in the industry for long life and low cost of ownership
- True rolling motion allows for higher speeds with minimum roller skewing or skidding
- Industry's broadest range of inch and metric sizes

Debris-Resistant Bearings

- Timken® debris-resistant bearings extend bearing life up to 3.5 times and are designed for tough, dirty conditions
- Proprietary alloy heat-treatment modifications and diamond-like coating technology interrupt adhesive wear and can self-repair microcracking
- Advanced manufacturing processes make these bearings economical in both large and small quantities



Cylindrical Roller Bearings

Minimize drag. Reduce heat. And perform better, for longer, with less maintenance and downtime. These are the true tests of any bearing. Our expanded line of cylindrical roller bearings – including single-, double- and multi-row versions and full complement designs – can help extend equipment life and reduce maintenance costs.

- EMA high-performance series offers premium brass land-riding cages that help decrease operating temperatures
- Improved mounting capabilities in the four-row line for metal mills help avoid roller/ring damage during roll change for increased uptime
- ADAPT™ line combines cylindrical and spherical roller bearing designs into one easy-to-assemble, high-capacity configuration – ideal for applications with combined misalignment and axial displacement



Spherical Roller Bearings

Misalignment. Contamination. High temperatures. Even extreme speeds or critical stresses can present extra challenges when managing high radial loads. Timken spherical roller bearings can handle it all, with innovations designed to extend bearing life and boost reliability.

- Run at consistently lower temperatures than same-size competitive bearings for greater reliability
- Multiple cage designs – including a wide range of both steel and brass options – help reduce stress at high shock loads or speeds and provide strong contaminant purge
- Optimized internal geometries deliver the highest load and speed ratings in the industry

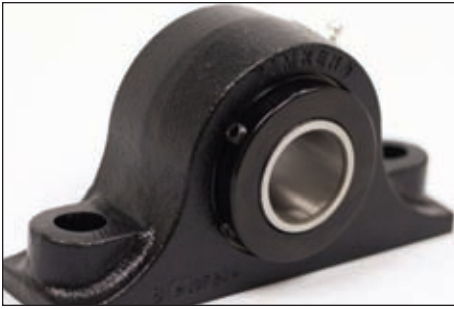

Type E Tapered Roller Bearing Housed Units

A new standard in performance, Type E tapered roller bearing housed units are ideal for fixed positions and can withstand the most demanding conditions with less downtime and maintenance.

- Seal provides industry-leading protection against contamination
- Optimized internal geometries offer the highest dynamic load ratings in the industry for improved bearing life and performance



Spherical Roller Bearing Solid Block Housed Units

Cast steel housings with high-performance spherical roller bearings deliver outstanding durability in extreme conditions, including severe shock loads and vibration.

- Multiple sealing options provide protection from contaminants in the harshest environments
- Can be mounted and aligned in 15 minutes with a variety of available shaft-locking mechanisms
- Easily convert from fixed to float configurations in the field



Ball Bearing Housed Units

Timken has delivered innovations that offer advanced performance, including wide inner ring bearing and ball bearing housed units. Easy installation, multi-seal design and multiple housing styles help ball bearing housed units support a wide range of demanding applications and conditions.

- Provide advanced protection against contaminants in a robust, compact unit
- Withstand static misalignment of +/- 3 degrees
- Effective grease retention and reduced debris and moisture ingress improve performance



SNT/SAF Plummer (Pillow) Block Housed Units

Customizable design, interchangeable components and reliable spherical roller bearings deliver the heavy-duty performance that helps protect equipment and improve uptime in the harshest environments.

- Variety of sealing options keep grease in and contamination out
- Easily convert from fixed to float configurations in the field
- Easy-to-remove cap for inspections, replacement and maintenance

Timken Product and Service Solutions

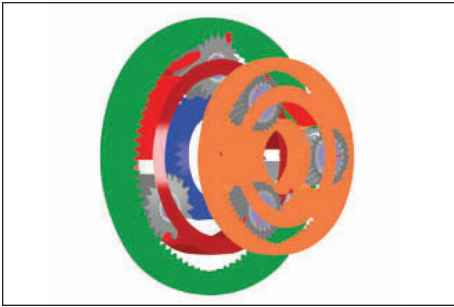

Advanced Bearing System Analysis

It's one of the most advanced bearing analysis tools available, with an unmatched, proprietary design that helps speed the system concept-to-design process with fewer test requirements. Our Syber Program analyzes bearing systems, helps optimize design and development, and predicts potential damage. And Timken customers also can perform base design analytics with their own version of this powerful software.

Bearing Remanufacturing

Buying new bearings can be costly. But our remanufacturing service can return bearings for heavy industrial, rail and aerospace applications – even other brands – to like-new condition, extending service life by up to three times, and saving up to 60% on the cost of replacement bearings.

Service Engineering

Driven to keep equipment running efficiently, our service engineers thrive on overcoming challenges and seeking ways to prevent future problems. Tapping into data, testing and technical resources, these experts offer on-site problem solving, life cycle calculations, interface design options, and bearing inspections and evaluations to uncover new paths to greater efficiency and productivity.



Maintenance Tools

Beyond making world-class bearings, we offer the precision tools to install, remove and maintain them in the easiest, safest manner possible. Applying our engineering know-how to the design of a variety of induction heaters, impact fitting tools, and hydraulic and mechanical pullers, Timken develops the tools needed to maximize productivity and uptime, including offering hands-on field training on their use and maintenance.

Industrial Services

Experience counts, and Timken has plenty of it when it comes to inspecting, repairing and upgrading gearboxes, electric motors and controls to OEM specs – regardless of manufacturer. Keeping industry in motion has been the driving force behind this dedicated service team, uniquely equipped with an expansive knowledge base, highly engineered equipment and superior problem-solving skills to supply and service the entire mechanical drive train system.

Training and Certification

Passing along more than a century of knowledge, our field service engineering network provides on-site training, end user maintenance seminars and bearing certification programs to help in selecting bearings and optimizing system performance. Our experienced engineers will tailor training to specific needs – from teaching the basics of bearings and proper installation to sharing time-tested practices and the latest technology. And our certification programs help maintenance shops gain efficiencies and improve performance.



Couplings

Designed for high and low torques, and high and low speeds, Quick-Flex® couplings have the strength to handle tough challenges with little or no maintenance. Easy to install and requiring no lubrication, their life spans match those of rotating equipment to help keep the overall cost of ownership low.

- Transmit the same or more torque than a gear, grid or other elastomeric coupling with similar dimensions
- Replace coupling insert without moving hubs – maintenance takes minutes instead of hours
- Sized to fit virtually all needs – with multiple hub and shaft combinations for easy mounting



Chain

Manufactured to meet or exceed ANSI standards, Timken chain performs. Our precision roller chain, attachment chain and engineered chain products excel in tough, high-performance applications and can be custom-manufactured to meet specific needs.

- Wide-waisted link plates improve stress distribution for better performance
- Precision hole quality increases working load and pin retention
- Can withstand shock loads up to 50% of minimum ultimate tensile strength without premature elongation
- Extensive range of stainless steel and coated options



Lubricants and Lubrication Systems

Serving industries around the world, Timken lubricants and lubrication systems are essential in maximizing performance, productivity and uptime. Leveraging our expertise in tribology and anti-friction bearings, we've developed lubricants – including 27 formulations of grease – that help ensure smooth operation. Our single- and multi-point lubricators, in addition to Interlube automated lubrication delivery systems, dispense precise amounts of grease, saving time and money over manual application.

- High-temperature, anti-wear and water-resistant additives optimize consistent operation in even the most challenging environments
- Multifaceted delivery systems serve virtually any application – from simple, single-point needs to multi-point or progressive systems where an automated process can maximize uptime and reduce maintenance costs
- Patented chain lubrication systems inject oil where it's needed for reduced wear



Seals

The ability to retain lubrication and block contaminants is critical to optimal bearing and system performance. Our complete line of industrial sealing solutions includes a variety of types and material options that provide resistance to extreme temperatures, pressure, debris and most chemicals.

- Contact and non-contact designs suit any application – with excellent sealing capability
- Durable materials can extend seal life and minimize maintenance
- Secondary seals, covers and endcaps provide extra protection in harsher environments

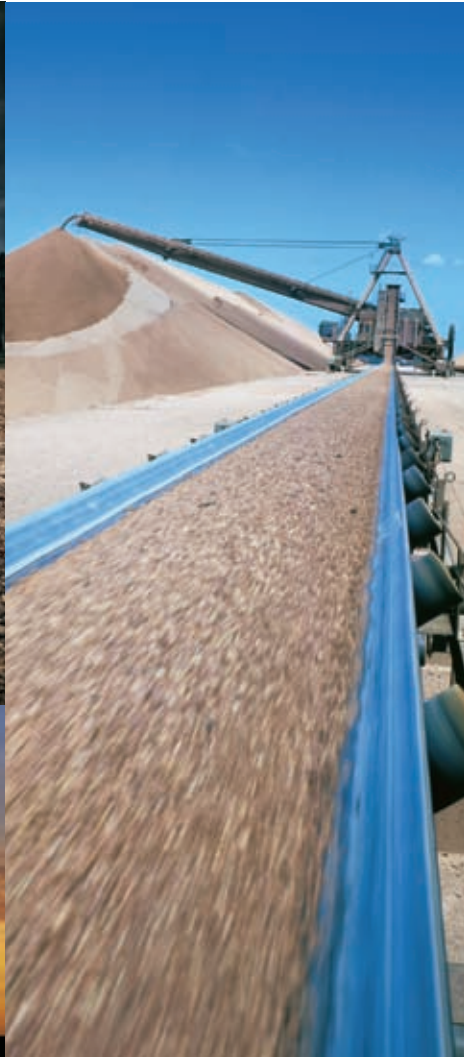

10M 11-14-29 Order No. 5892 | Timken® is a registered trademark of The Timken Company. | © 2014 The Timken Company. | Printed in U.S.A.

TIMKEN

The Timken team applies their know-how to improve the reliability and performance of machinery in diverse markets worldwide. The company designs, makes and markets high-performance mechanical components, including bearings, gears, chain and related mechanical power transmission products and services.

www.timken.com

Stronger. **Commitment.** Stronger. **Value.** Stronger. **Worldwide.** Stronger. **Together.** | Stronger. **By Design.**