

TRW Automotive
Commercial Steering Systems

TAS Poppets

A Workbook and Self-Test
to be used with the
TRW TAS Poppet Setting Video

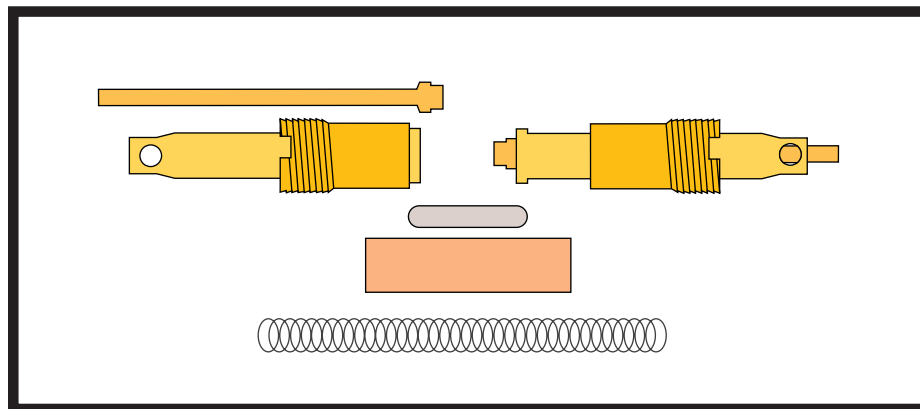

Follow all precautions and warnings in Service
Manual when setting or resetting poppets

What Poppets Are:

Poppets reduce pressure in full right and left turns

- Reduces hydraulic system heat
- Reduces force on linkage components

Pressure and heat build up in the steering system during turning maneuvers.

High temperatures can deteriorate the hydraulic system over time.

High pressure could put a lot of stress on linkage components over time.

How Poppets Work:

Rotating input shaft causes rack piston to move

Lower poppet in rack piston contacts fixed stop bolt or adjusting screw

Upper poppet in rack piston contacts valve housing

Contact of poppet and screw or valve housing pushes poppet away from it's seat.

Gap between poppet and seat allows fluid to pass through the rack piston, reducing pressure.

Poppet should contact screw or valve housing just before axle contacts axle stop.

TAS Poppet Components:

- Two Poppet Seat and Sleeve Assemblies
- Two Poppets
- Spring
- Nylon Spacer Rod
- Push Tube

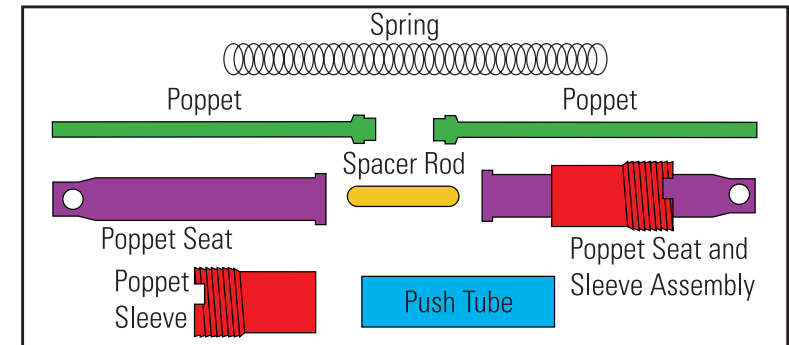

Setting poppets means pushing the poppet seat into the poppet sleeve. This backs off the poppet so it will contact the screw or valve housing just before axle contacts axle stop

TAS Factory Setting: (or New Aftermarket Gear)

- Set axle stops
- Raise front axle
- Turn full right - engine on
- Turn full left - engine on

New steering gear poppet components look like this before setting. At this point, they are ready for automatic adjustment.

The amount of gear travel is determined on each vehicle by the axle stop settings. End of gear travel is marked in these diagrams by dotted lines. The rack piston will stop when it reaches these points because the axle stops will not allow the road wheels to travel further.

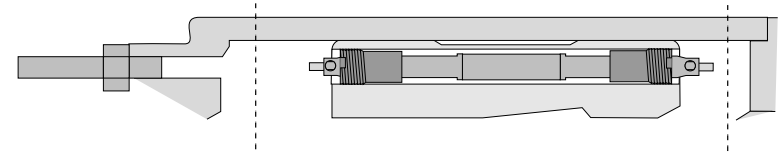

On the first full turn after installation on a vehicle, the poppet seat will make contact internally, and be pushed into the sleeve. Since the rack piston has travelled to its farthest point for the vehicle, the poppet seat, in its new set position, has also reached its farthest point of travel.

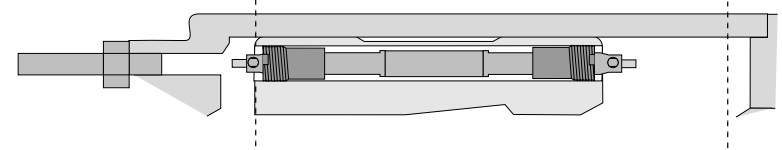

In the second full turn, the remaining poppet seat will be pushed in the amount required for that vehicle. Since the poppet seat and sleeve assemblies are a pressed fit, both poppet seats will now remain in this set position until they are reset using the procedure that follows.

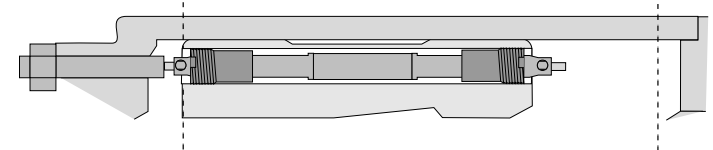

Notice that the poppets were adjusted along with the poppet seat. In all subsequent turns, the poppet will be pushed off the seat to reduce pressure, and the poppet seat should never again make contact with the housing or the fixed stop screw.

When the poppet makes contact, pressure is reduced which also reduces the power assist felt at the steering wheel. Axle to axle stop contact can still be achieved, but with manual steering only.

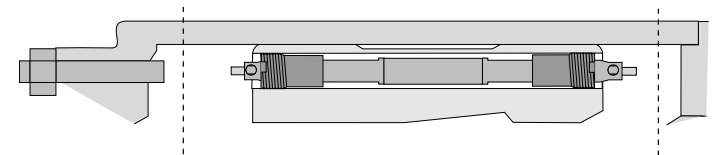

Reasons for Resetting Poppets:

- Changing to larger tires
- Reducing wheelcut for any reason
- If the steer axle u-bolts were bent or broken
- If the pitman arm was mistimed
- Axle stop bolts were damaged
- Steering gear is mounted on a different vehicle

TAS Resetting:

- Set axle stops
- Install adjusting screw
- Raise Front Axle
- Start Engine
- Turn in the direction that moves the inner output shaft timing mark toward adjusting screw
- Pull hard on the steering wheel
- Turn in opposite direction, pull hard on the steering wheel
- Turn off engine
- Back out adjusting screw until 1" is past the nut
- Start engine
- Turn steering wheel in original direction, pull hard when axle stop contact is made
- Screw in adjusting screw until it stops
- Back out adjusting screw 3 1/4 turns
- Torque jam nut
- Turn off engine, lower vehicle

Introduction to Internal Components

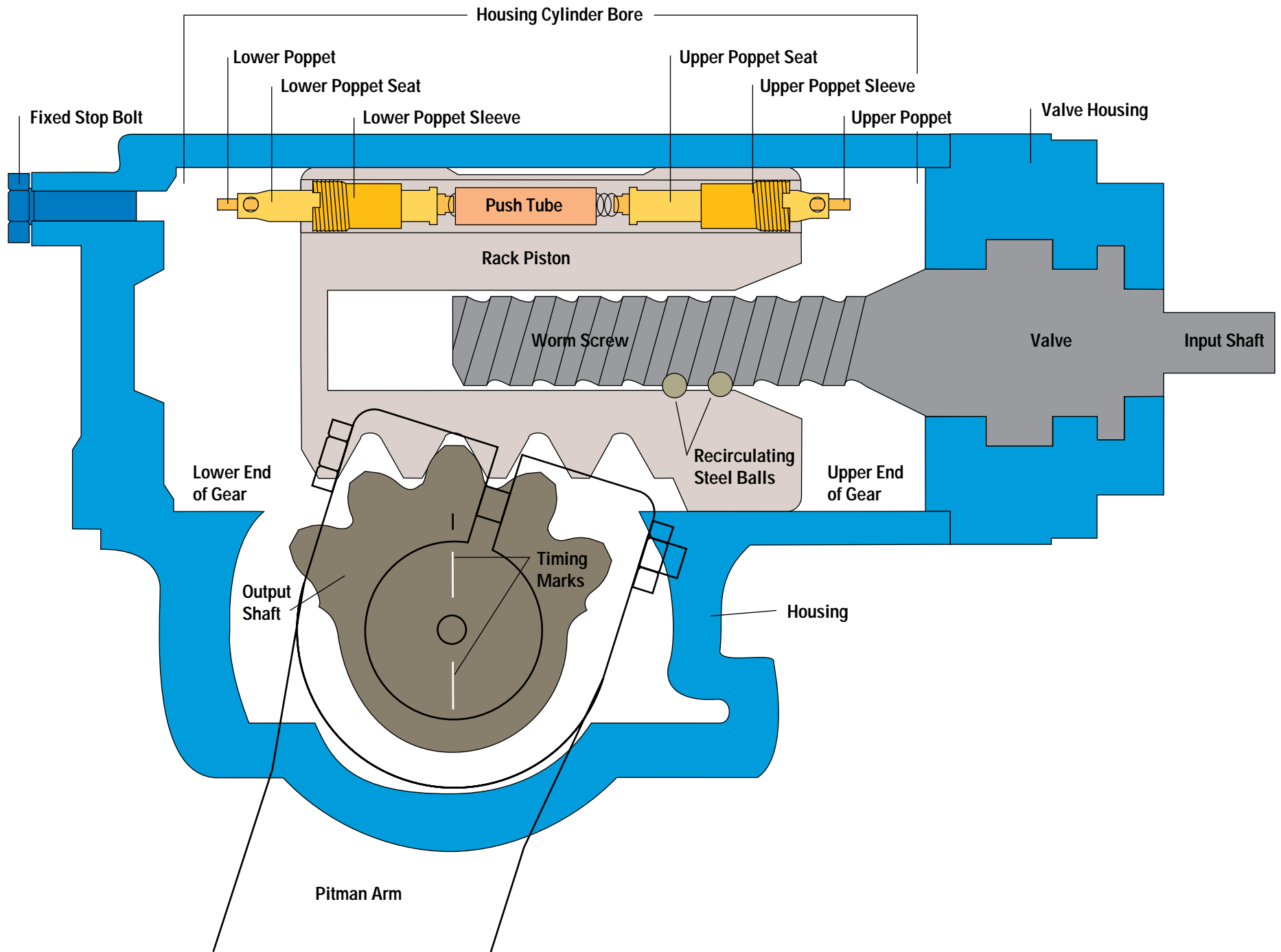

Axle stops have been reset in this diagram. They have been moved in, indicating that wheel cut has been reduced.

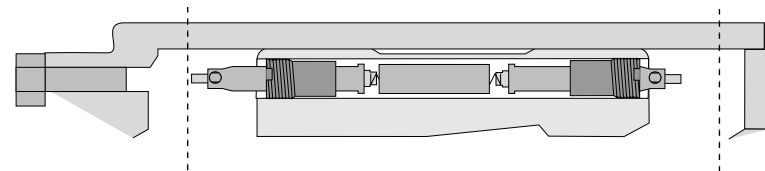

An adjusting screw is installed in the gear for the resetting process so the poppet components can be forced together to push on one another. Once the poppet components are pushed together, they will stay that way. The adjusting screw will also remain as part of the gear. Do not try to reuse the fixed stop screw after resetting poppets.

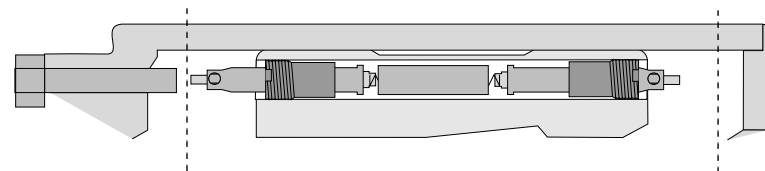

Turning in a direction that makes the rack piston move toward the lower end of the steering gear will force the lower poppet seat against the adjusting screw. The lower poppet seat then contacts the push tube and forces it against the upper poppet seat. This will force the upper poppet seat out so it can be set automatically on the next turn.

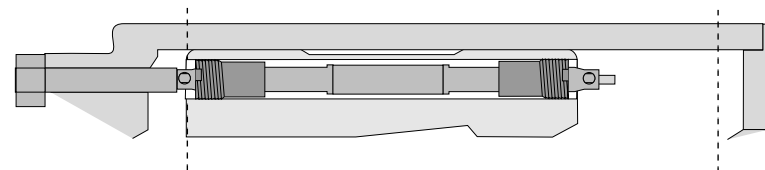

This turn sets the upper poppet seat in just the same way as it was set when the gear was new. Notice that since the poppet components are still forced together, the upper poppet seat is now forcing the push tube against the lower poppet seat to push it out.

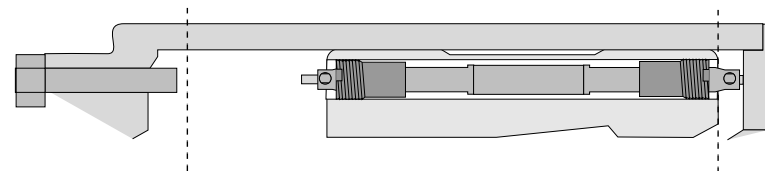

The adjusting screw is backed out of the way, so the poppet seat will not contact it on the next turn.

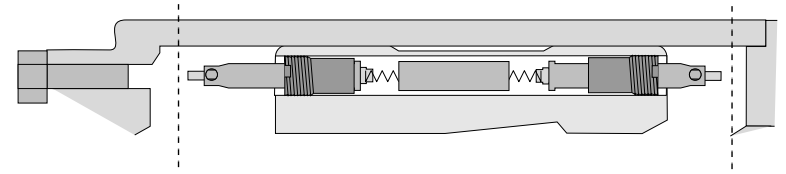

Holding the wheel at full turn places the poppet seat in the proper position for setting.

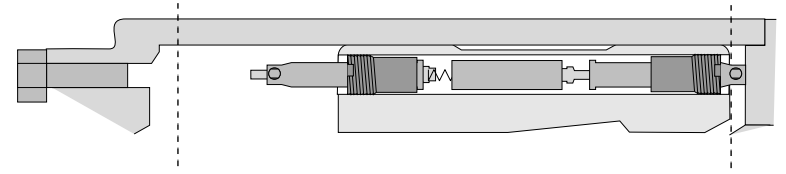

The adjusting screw is then turned in to meet the lower poppet seat and backed-out 3 1/4 turns.

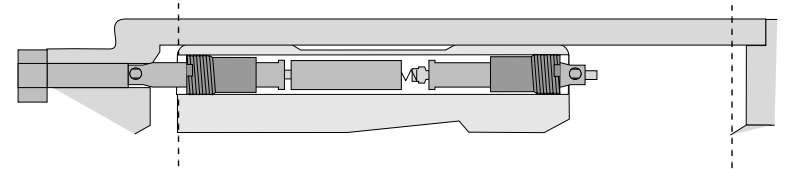

The adjusting screw remains in this position, and acts as the contact point for the lower poppet until poppets need to be reset again.

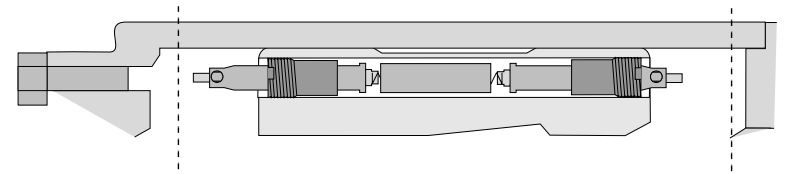

Self-Test:

1. Poppets reduce system pressure:
 - A. After full turn
 - B. When axle stop contact is made
 - C. Just before full turn
2. Reducing pressure lessens:
 - A. Temperature in the hydraulic system
 - B. Stress on the linkage
 - C. Both
3. A good reason to reset poppets would be:
 - A. Wheelcut has been reduced
 - B. Loose Steering
 - C. Wheel kick
4. Always set axle stops before setting poppets.
 - A. True
 - B. False
5. If the sector shaft timing mark points toward the upper poppet, you should set the lower poppet.
 - A. True
 - B. False

Glossary of Terms:

Gear Families - TAS Family = TAS40, TAS55, TAS65, TAS85 (RCS cylinders are TAS gears without worm and valve).
HFB Family = HFB52, HFB64, HFB70 (RCB cylinders are HFB gears without worm and valve)
HF Family = HF54, HF64

Linear Cylinder - A cylinder with a piston rod that provides in/out thrust.

Lower End - End of cylinder bore farthest from the input shaft.

Master Gear - Main steering gear, located on driver's side of vehicle.

Pressed Fit - The fitting of two components that allows a controlled movement between them, but will not allow them to move during normal operational actions.

Pump Relief Pressure - Maximum pressure of the power steering pump.

Rim Pull - Force used to turn the steering wheel, measured in pounds at the rim of the steering wheel.

Slave Gear - Auxiliary gear on passenger side of vehicle. Has no worm screw, ball-nut mechanism, or control valve.

Steering System - Includes mechanical and hydraulic components: steering wheel, column, u-joints, slip joints, miter box, steering gear, pump, reservoir, hoses and connections, pitman arm, drag link and sockets, axle arm, king pin, bushings, tie rod arms and ends, steering spindle, wheel bearings, springs and spring pin connectors, spring hanger brackets, front axle, u-bolts.

Steering Wheel Travel - Number of times the steering wheel can rotate between full turns.

Thread Engagement - The amount of contact between threads on screw and nut.

Timing Marks - Use the output shaft timing mark nearest the cylinder bore to judge which poppet to set.

Upper End - End of cylinder bore nearest the input shaft.

Answers to the Self-Test:

1. C
2. C
3. A
4. A
5. B

TAS Poppet Workbook



TRW Commercial Steering Systems

800 Heath Street

Lafayette, IN 47904

Phone: 765/423-5377

Fax: 765/423-4453